



VOGUE UK

TOWEL WARMERS & RADIATORS





# VOGUE UK

TOWEL WARMERS & RADIATORS

EST | 1990

Welcome to Vogue UK – the country's leading manufacturer of heated towel warmers, designer radiators and accessories. Established in 1990 within the heart of the West Midlands, and still privately owned by its original founders, Vogue UK continues to design and create more products than any other company in this field, constantly leading the trend by combining fashion with functionality.

Everyone has their own sense of style and that's why Vogue UK has created a range of quintessential products that meet the needs of every interior design style. If you require something unique then our craftsmen can create a design to your exact brief. As Vogue UK have been creating towel warmers and designer radiators since 1990 the company has built an extensive portfolio of designs and can offer a bespoke service, ideal if you're looking to create an authentic period look or simply match an existing design.

Our seven categories of products in this brochure and on our website are sure to encompass the perfect design for you...no matter what shape, style or size you're looking for.





## From contemporary to traditional

**We've been at the forefront of towel rail and radiator design for 30 years. It's easy to see why.**

We work with some of the UK's leading interior designers who create a range that's unlike anything else. Full of inspiration and innovative design in stunning colours and finishes, we turn heating your room into a style statement.

Plus, we know every home is unique in so many ways and we've created a range that reflects the style and personality of our homes today. From timeless classics, expertly engineered for modern life, to cutting edge contemporary design that gives you a glimpse of the future - whatever your style, you'll find the perfect one for you.

*Fashion and  
functionality,  
beautiful crafted*

Contemporary	10 - 65
Ladder Rails	66 - 83
Traditional	84 - 117
Designer Radiators	118 - 139
Electric	140 - 147
Additions	148 - 157
Bespoke Service	158 - 160

BE SPOKE

## | Designed around you

We know one size, one colour or even one style doesn't fit all. It's why we offer three levels of our bespoke design and manufacture service.

### Customise our collection

If you like what you see, but it doesn't fit your exact requirements, no problem. You can customise your towel rail or radiator dimensions, materials and finishes.

### See your design come to life

We can work from any design specification and handcraft special products from high-quality brass, stainless steel or mild steel. We will offer expert advice to ensure your design not only looks amazing, but performs too.



## Bespoke Colours

From bright bold gloss colours to soft, relaxing muted tones. Shimmering metallic finishes to hardwearing crackle paints, we have the right colour for your home.

Page 158

## Joints

When creating a stylish towel rail or radiator the joint details can make all the difference. We have 15 different designs to choose from, all expertly handcrafted by us.

Page 160

Fully commissioned project work with our team of designers and engineers in this collaborative design process to create exactly what you are looking for. We'll bring your vision to life and manufacture your bespoke towel rail or radiator.

*Designs are created  
with care, precision  
and passion*



## Valves & Accessories

From simple and stylish to ornate, time-honoured designs, we have a range of valves & accessories that add the perfect finishing touch to your creation

Pages 154 - 157

## Tubing

Simple, smooth and round to hexagonal and embellished options. We have lots of styles to choose from. So, pick your tubing and put your individual stamp on your design.

Page 160



# VOGUE UK

## TOWEL WARMERS & RADIATORS

The evolution of the heated towel warmer stretches way back into the 1800's. In 1834 a man named Denison Olmstead of New Haven, Connecticut created a heat exchanger for his stove which he described as a 'peculiar kind of apparatus, which I call a radiator'. However, it wasn't until 1855, Franz San Galli of St. Petersburg invented the heating radiator.

So the journey began... the radiator became more popular and spread to every room in the home. Once heating reached the bathroom it became unrealistic for towels to dry and pile-up on the radiator and so, the inevitable arrival of the towel warmer came to pass.

The 1920's saw the first of the cast iron water heated towel warmers, commonly referred to as a 'bath radiator'. Here in the UK, drying racks, heated towel warmers and heated towel bars were seen as luxury items and would only ever be found in homes and hotels of high upstanding social status.

As time passed, new materials became available and our abilities to manipulate and manufacture these materials grew. Materials such as copper, brass, mild steel and stainless steel helped to propel the industry forward.

Arriving in the present day and now we have yet more advancement brought to you by Vogue UK, who for 30 years has been manufacturing and innovating many styles and designs into the towel warmer arena.



## Brass Manufacture

BR

### DZR Brass

The highest quality brass available in a finish of your choice. Corrosion resistant and provides a superior plated finish.

30

### 30 year quality assurance Warranty

On our brass products showing this symbol.

H

### Heating and Hot Water

Suitable for all heating and hot water systems.

## Stainless Steel Manufacture

SS

### Stainless Steel

Giving an easy to clean finish that is resistant to corrosion and has a high heat output.

30

### 30 year quality assurance Warranty

On our stainless steel products showing this symbol.

H

### Heating and Hot Water

Suitable for all heating and hot water systems.

## Mild Steel Manufacture

MS

### Mild Steel

Quality mild steel available in chrome and painted finishes suitable for indirect/closed heating systems.

15

### 15 year quality assurance Warranty

On mild steel products showing this symbol.

C

### Heating Only

Suitable for closed indirect heating systems.

## Aluminium Manufacture

AL

### Aluminium

Providing a quick heat up time thus allowing for greater efficiency with a low water content.

30

### 30 year quality assurance Warranty

On our aluminium products showing this symbol.

H

### Heating and Hot Water

Suitable for all heating and hot water systems.

## Additional Requirements

E

### Electric Only

Can be specified where this symbol is displayed. Please see page 152 for full range and price supplements.

DL

### Electric Dryline

Can be specified where this symbol is displayed. Dryline technology, heating via a heater cable. POA

D

### Heating and Electric

Can be specified where this symbol is displayed. Please see page 152 for full range and price supplements.

2

### 2 year quality assurance Warranty

On our products showing this symbol.



### RAL Colours

Available in RAL colour Chart options. Please see page 158 for colour options and price supplement.

## Stock Information



### Stocked Item

The 'Tick' symbol in the product specification tables denotes a stocked item.



### Additional Production Process

The 'Stopwatch' denotes a stocked item that under goes additional production processes to achieve chosen finish.



### Made-to-order

The 'Handprint' symbol in the product specification tables denotes a made to order product.

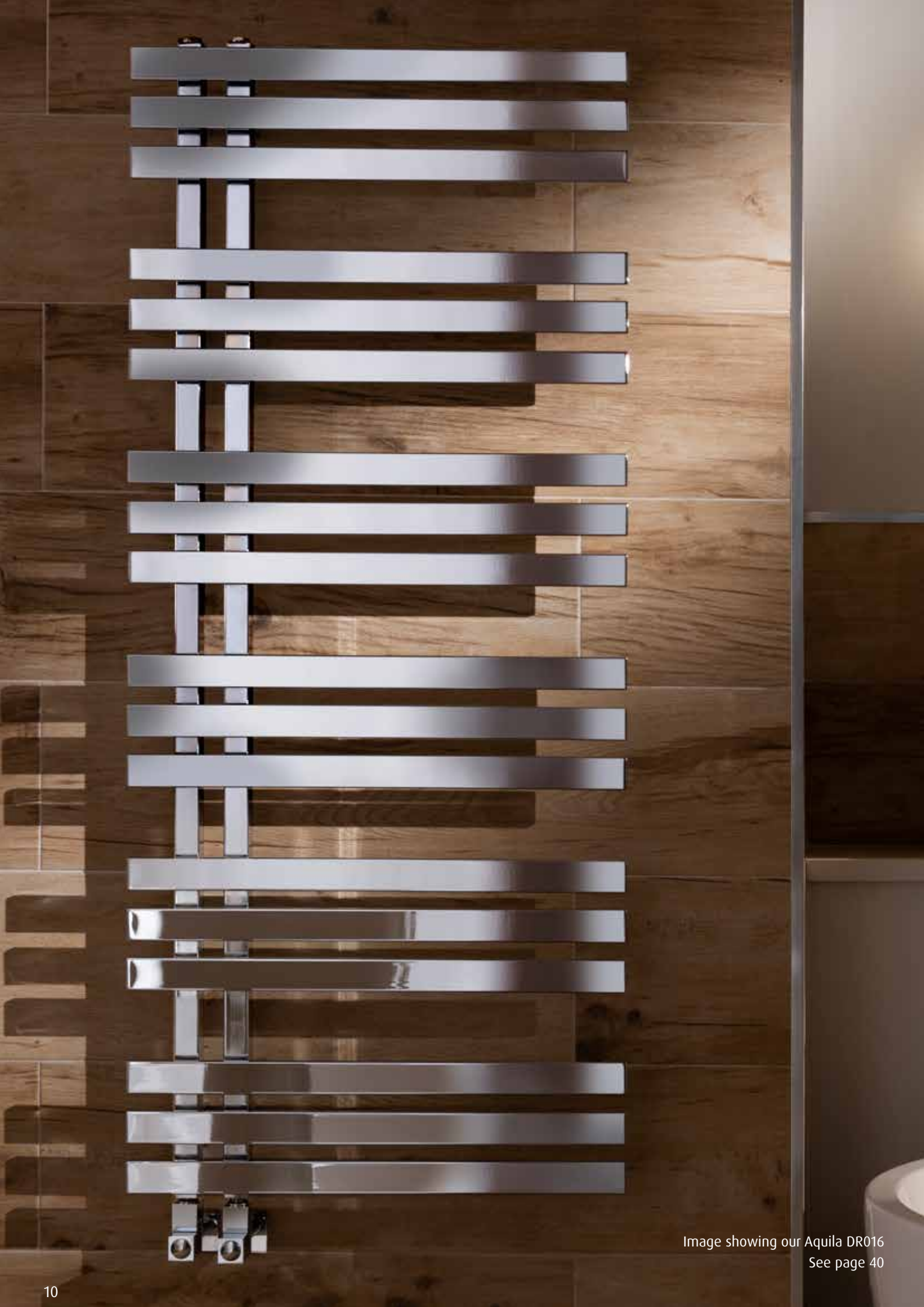

Image showing our Aquila DR016  
See page 40

A modern bathroom scene featuring a white bathtub, a wooden vanity, and decorative elements like vases and a lamp. The scene is lit with warm, ambient light from a wall sconce. The text 'Contemporary' is centered in the upper half of the image.

## Contemporary

Clean lines, stunning finishes, and amazingly practical too. Make a statement with our range of contemporary designs that are leading the way in modern towel rail and radiator innovation.

# Concertina

## Wall Mounted DR010

Concertina is a beautiful iconic rail. Towels slide easily in from the side and can be left or right hand mounted. Manufactured from high quality mild steel. Prices shown are for chrome finished for central heating models.



MS 15 C D E

For electric element & valve options see pages 152 & 156



### Concertina

Tube diameter Ø 19 + 32mm	Dimensions (mm)			Bar Config	Pipe Centres	Electric Element wattage	Output ΔT 50°C Watts/BTU's	Output ΔT 60°C BTU's
	H	W	D					
DR010	1000	500	111	12	75	150	226 / 771	975
DR010	1000	600	111	12	75	200	311 / 1061	1341
DR010	1200	500	111	14	75	200	383 / 1307	1652
DR010	1200	600	111	14	75	300	423 / 1443	1824

The Marine's innovative design is a focal point for any bathroom. The looped horizontal rails maximise both heat output and hanging space. Manufactured from high quality mild steel. Prices shown are for chrome finished for central heating models.

# Marine

## Wall Mounted DR009



For electric element & valve options see pages 152 & 156

VL003

MS 15 C D E

### Marine

Tube diameter Ø 19 + 32mm	Dimensions (mm)			Bar Config	Pipe Centres	Electric element wattage	Output	Output
	H	W	D				ΔT 50°C Watts/BTU's	ΔT 60°C BTU's
DR009	1400	600	177	25	110	400	767 / 2617	3308

# Cygnus

## Wall Mounted DR012

Cygnus is handsome and highly practical design. The looped horizontal rails maximise both heat output and hanging space. Finished in chrome. Manufactured from high quality mild steel. Prices shown are chrome finish for central heating models.



MS 15 C D E

For electric element & valve options see pages 152 & 156



### Cygnus

Tube diameter Ø 19 + 32mm	Dimensions (mm)			Bar Config	Pipe Centres	Electric element wattage	Output ΔT 50°C Watts/BTU's	Output ΔT 60°C BTU's	Stock or made to order
	H	W	D						
DR012	900	500	170	4-4-10	300	150	417 / 1423	1798	✓
DR012	1200	500	170	4-4-4-11	300	200	556 / 1897	2398	✓

A unique looped rail encompassing a vertical contemporary radiator adds a beautifully smooth and contemporary feel to any space. The coiled bars bring an intricacy whilst providing abundant towel hanging space.

# Cygnus Harmonique

Wall Mounted DR032



Manufactured from high quality mild steel. Prices shown are chrome finish for central heating models.



For electric element & valve options see pages 152 & 156



## Cygnus Harmonique

Tube diameter Ø 19 + 32mm	Dimensions (mm)			Bar Config	Pipe Centres	Electric element wattage	Output ΔT 50°C Watts/BTU's	Output ΔT 60°C BTU's	Stock or made to order
	H	W	D						
DR032	1200	500	159-174	23	300	400	908 / 3098	3916	✓

Sales: +44 (0) 1902 387000 | 15

# Draco

## Wall Mounted DR015

Draco's equally spaced hooped tubes form an architectural shape. Perfect symmetry with centralised valves. Finished in chrome, a must for any modern setting. Manufactured from high quality mild steel. Prices shown are chrome finish for central heating models.



MS 15 C D E

For electric element & valve options see pages 152 & 156



### Draco

Tube diameter		Dimensions (mm)			Bar Config	Pipe Centres	Electric element wattage	Output $\Delta T$ 50°C Watts/BTU's	Output $\Delta T$ 60°C BTU's	Stock or made to order
$\varnothing$ 19mm	$\square$ 30 x 30mm	H	W	D						
DR015		1000	500	160	9	86	125	236 / 805	1018	✓
DR015		1300	500	160	13	86	150	272 / 928	1173	✓



Unique design and bold tubes, the Sierra provides a statement product and increased towel drying capacity. Available in an Anthracite finish, manufactured in high quality mild steel. Prices shown are for central heating models.

# Sierra

## Wall Mounted DR040



New for 2021

MS 15 C D E

For electric element & valve options see pages 152 & 156



VL003

### Sierra

Tube diameter □ 35 x 35 + 60 x 12	Dimensions (mm)			Bar Config	Pipe Centres	Electric element wattage	Output ΔT 50°C Watts/BTU's	Output ΔT 60°C BTU's	Stock or made to order
	H	W	D						
DR040	850	500	125	2+3+3	300	150	524 / 1788	2260	✓
DR040	1200	500	125	2+3+3+3	300	200	683 / 2330	2946	✓
DR040	1550	500	125	3+3+4+6	300	300	966 / 3296	4166	✓

Sales: +44 (0) 1902 387000 | 17

# Flexx

## Wall Mounted CN015

Flexx is sensual and curvaceous. This handcrafted towel rail is an original design, with all the functionality a fabulous towel rail must have. Manufactured by craftsmen in high quality brass tube, chromed to a mirror finish.



Image showing Polished Brass finish

Please note: Electric and dual energy versions come with a straight bottom bar.

Please see pages 158 & 159 for finishes and colour options. Prices shown are chrome finished for all heating and hot water systems.



For electric element & valve options see pages 152 & 156



### Flexx

Tube diameter Ø 31.8 + 50.8mm	Dimensions (mm)			Bar Config	End to End connections	Electric element wattage	Output ΔT 50°C Watts/BTU's	Output ΔT 60°C BTU's	Stock or made to order
	H	W	D						
CN015	1240	540	250	15	540	300	642 / 2191	2769	

When space is limited, you still want good design and high heat output, the Intra ticks all the boxes. The towel rail fits neatly into a corner to maximise wall space and is available in two sizes. Manufactured from large diameter brass or mild steel tube.

# Intra

## Wall Mounted CN013



Bespoke finishes are available at an additional cost. Please see pages 158 & 159 for finishes and colour options. Prices shown are chrome finished for central heating systems.



For electric element & valve options see pages 152 & 156



### Intra -BR

Tube diameter Ø 31.8 + 50.8mm	Dimensions (mm)			Bar Config	Pipe Centres	Electric element wattage	Output ΔT 50°C Watts/BTU's	Output ΔT 60°C BTU's	Stock or made to order
	H	W	D						
CN013	1240	500	350	5-5-5	325 + 475	200	607 / 2071	2618	👤
CN013	1680	500	350	5-5-5-5	325 + 475	300	814 / 2777	3511	👤



### Intra - MS

Tube diameter Ø 31.8 + 50.8mm	Dimensions (mm)			Bar Config	Pipe Centres	Electric element wattage	Output ΔT 50°C Watts/BTU's	Output ΔT 60°C BTU's	Stock or made to order
	H	W	D						
CN013-MS	1240	556	306	5-5-5	281 + 531	200	525 / 1791	2264	✓
CN013-MS	1680	556	306	5-5-5-5	281 + 531	300	703 / 2399	3032	✓

# Grace

## Wall Mounted MD067

Understated with great towel hanging functionality, Grace is the epitome of simple chic design. Manufactured from large diameter high quality mild steel. Prices shown are chrome finished for central heating models.



For electric element & valve options see pages 152 & 156



VL003

### Grace

Tube diameter Ø 38mm	Dimensions (mm)			Bar Config	Pipe Centres	Electric element wattage	Output ΔT 50°C Watts/BTU's	Output ΔT 60°C BTU's	Stock or made to order
	H	W	D						
MD067	800	500	100	3	462	100	140 / 478	604	✓
MD067	1200	500	100	4	462	125	199 / 679	858	✓

A simple yet sophisticated piece. With a chunky tube creating a robust and full bodied look, this will add a high quality and classy statement to your bathroom or en suite. Chromed to a mirror finish. Prices shown are chrome finished for all heating and hot water systems.

# Mantra V

## Wall Mounted CN075



- MS
- 15
- C
- D
- E
- 

For electric element & valve options see pages 152 & 156



### Mantra V

Tube diameter Ø 32 + 51mm	Dimensions (mm)			Bar Config	Pipe Centres	Electric element wattage	Output ΔT 50°C Watts/BTU's	Output ΔT 60°C BTU's	Stock or made to order
	H	W	D						
CN075	1240	500	125	14	449	200	408 / 1392	1760	✓

Sales: +44 (0) 1902 387000 | 21

# Pure

## Wall Mounted MD037

Pure high quality elegance. This hand-crafted towel rail is manufactured in brass and chromed to a mirror finish. Bespoke finishes are available at an additional cost. A perfect size for smaller areas where space is at a premium and quality a must.



Image showing Antique Bronze finish

Please see pages 158 & 159 for finishes and colour options. Prices shown are chrome finished for heating and hot water systems.



For electric element & valve options see pages 152 & 156



### Pure

Tube diameter Ø 25.4 + 19mm	Dimensions (mm)			Bar Config	Pipe Centres	Electric element wattage	Output ΔT 50°C Watts/BTU's	Output ΔT 60°C BTU's	Stock or made to order
	H	W	D						
MD037	700	425	75	4	400	75	106 / 362	457	

A contemporary chrome oval tube towel warmer that can be left or right hand mounted. Manufactured from mild steel, suitable for closed heating systems and with a 15 year Warranty.

Amie

Wall Mounted CN065



Please see pages 158 & 159 for finishes and colour options. Prices shown are for chrome finished central heating models.



For electric element & valve options see pages 152 & 156



Amie

Tube diameter ∅ 30 x 30 Sq + 25 x 50 Oval	Dimensions (mm)			Bar Config	Pipe Centres	Electric element wattage	Output ΔT 50°C Watts/BTU's	Output ΔT 60°C BTU's	Stock or made to order
	H	W	D						
CN065	1200	500	125-137	3-3-3	80	200	237 / 809	1022	✓
CN065	1500	500	125-137	3-3-3-3	80	400	309 / 1054	1333	✓

Sales: +44 (0) 1902 387000 | 23

# Chic

## Wall Mounted MD046

Chic gives ultimate versatility allowing towels to be accessed from the side. This practical and stylish design is available chrome plated. Manufactured from high quality mild steel which can be mounted to the left or right.



Prices shown are chrome finished for central heating models.



For electric element & valve options see pages 152 & 156



### Chic

Tube diameter		Dimensions (mm)			Bar Config	Pipe Centres	Electric element wattage	Output $\Delta T$ 50°C Watts/BTU's	Output $\Delta T$ 60°C BTU's	Stock or made to order
$\varnothing$ 22mm	$\square$ 30mm	H	W	D						
MD046		1200	500	85	3-3-3-3-3	100	150	282 / 962	1216	✓



A contemporary, minimalist design with crisp clean lines. Keys II allows towels to be effortlessly hung onto the rails from the left or right hand side, depending on your requirements. Manufactured from high quality mild steel, chromed to a mirror finish.

# Keys II

## Wall Mounted CN030



Prices shown are for central heating models. Stainless Steel version available on request



For electric element & valve options see pages 152 & 156



### Keys II

Tube diameter □ 30sq + 40sq mm	Dimensions (mm)			Bar Config	Pipe Centres	Electric element wattage	Output ΔT 50°C Watts/BTU's	Output ΔT 60°C BTU's	Stock or made to order
	H	W	D						
CN030	1080	500	141	6	50	150	392 / 1338	1691	✓
CN030	1460	500	141	8	50	200	524 / 1788	2260	✓

# Smooth

## Wall Mounted CN035

Smooth combines excellent towel hanging space with high heat output and eye catching design. Manufactured from high quality mild steel. Prices shown are chrome finished for central heating systems models.



For electric element & valve options see pages 152 & 156

### Smooth

Tube diameter Ø 32 + 22mm	Dimensions (mm)			Bar Config	Pipe Centres	Electric element wattage	Output ΔT 50°C Watts/BTU's	Output ΔT 60°C BTU's	Stock or made to order
	H	W	D						
CN035	800	400	94	9	368	100	163 / 556	703	✓
CN035	800	500	94	9	468	125	189 / 645	815	✓
CN035	1200	400	94	13	368	150	235 / 802	1014	✓
CN035	1200	500	94	13	468	150	271 / 925	1169	✓

Smooth II is modern and stylish, featuring 38mm vertical tubes. Manufactured from high quality mild steel with mitred corners. Prices shown are chrome finished for central heating systems.

# Smooth II

## Wall Mounted CN036



- MS
- 15
- C
- D
- E
- 

For electric element & valve options see pages 152 & 156



### Smooth II

Tube diameter Ø 38 + 32mm	Dimensions (mm)			Bar Config	Pipe Centres	Electric element wattage	Output ΔT 50°C Watts/BTU's	Output ΔT 60°C BTU's	Stock or made to order
	H	W	D						
CN036	800	400	96	8	368	125	206 / 703	888	✓
CN036	800	500	96	8	468	150	237 / 809	1022	✓
CN036	1200	400	96	11	368	200	292 / 996	1259	✓
CN036	1200	500	96	11	468	200	335 / 1143	1445	✓

# Zenith

Zenith is manufactured in stainless steel and has a brushed or polished finish, suitable for all heating & hot water systems. Please see page 158 for colour options.

## Wall Mounted IN007



SS 30 H D E 

For electric element & valve options see pages 152 & 156



### Zenith

Tube diameter 	Dimensions (mm)			Bar Config	Pipe Centres	Electric element wattage	Output $\Delta T$ 50°C Watts/BTU's	Output $\Delta T$ 60°C BTU's	Stock or made to order
	H	W	D						
40sq + 30sqmm									
IN007	1200	400	90	6	360	125	421 / 1436	1816	

Contrasting design with square mitred outer tubes and round cross bars. The Contrast is a hybrid product with 50mm centres with the option for an electric element to go up the vertical square tube without the need for a conversion tee for dual fuel models.

# Contrast

## Wall Mounted MD079



New for 2021

Available in Matt Black and Matt White Textured finish. Prices shown are for central heating models.

MS 15 C D E

For electric element & valve options see pages 152 & 156



### Contrast

Tube diameter 50sq 38mm	Dimensions (mm)			Bar Config	Pipe Centres	Electric element wattage	Output $\Delta T$ 50°C Watts/BTU's	Output $\Delta T$ 60°C BTU's	Stock or made to order
	H	W	D						
MD079	800	500	105-120	3-7	50	300	447 / 1525	1928	✓
MD079	1200	500	105-120	3-5-7	50	400	628 / 2143	2708	✓
MD079	1500	500	105-120	3-4-5-7	50	600	770 / 2627	3321	✓

# Quadrate

## Wall Mounted MD074

Quadrate has 50mm vertical tubes and crisp, sleek edges, which would suit any modern bathroom setting. Available in a range of heights and widths. Manufactured from high quality mild steel. Prices are for chrome central heating models.

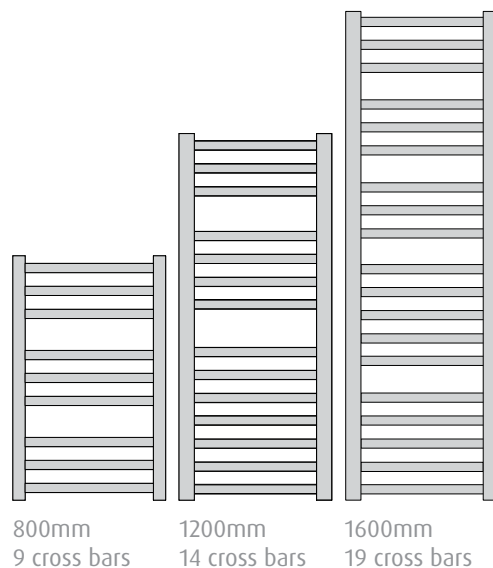

For electric element & valve options see pages 152 & 156

VL014

### Quadrate

Tube diameter □ 50sq + 30sq mm	Dimensions (mm)			Bar Config	Pipe Centres	Electric element wattage	Output ΔT 50°C Watts/BTU's	Output ΔT 60°C BTU's	Stock or made to order
	H	W	D						
MD074	800	500	105	3-3-3	450	150	271 / 925	1169	✓
MD074	800	600	105	3-3-3	550	200	310 / 1058	1337	✓
MD074	1200	500	105	3-4-7	450	300	416 / 1419	1794	✓
MD074	1200	600	105	3-4-7	550	300	477 / 1628	2057	✓
MD074	1600	500	105	3-3-3-5-5	450	400	561 / 1914	2419	✓
MD074	1600	600	105	3-3-3-5-5	550	600	645 / 2201	2782	✓

A strikingly functional product with a high heat output, multiple crossbars for optimum towel hanging capabilities. The square tubing presents a fresh, contemporary look for a clean profile.

# Quadrate Harmonique

Wall Mounted MD078

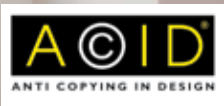

Finished in chrome. Manufactured from high quality mild steel. Prices shown are chrome finish for central heating models. Please Note: Colour option only applies to the inset radiator, not the frame.



For electric element & valve options see pages 152 & 156



## Quadrate Harmonique

Tube diameter □ 50sq + 30sq mm	Dimensions (mm)			Bar Config	Pipe Centres	Electric element wattage	Output ΔT 50°C Watts/BTU's	Output ΔT 60°C BTU's	Stock or made to order
	H	W	D						
MD078	1200	500	105-120	7	450	400	1003 / 3422	4326	✓

Sales: +44 (0) 1902 387000 | 31

# Rubik

## Wall Mounted MD038

Simple and beautiful, the rectangular stainless steel tube is built to last. The Rubik comes in polished stainless steel as standard. Please see pages 158 & 159 for finishes and colour options. Stainless steel construction suitable for all hot water systems.

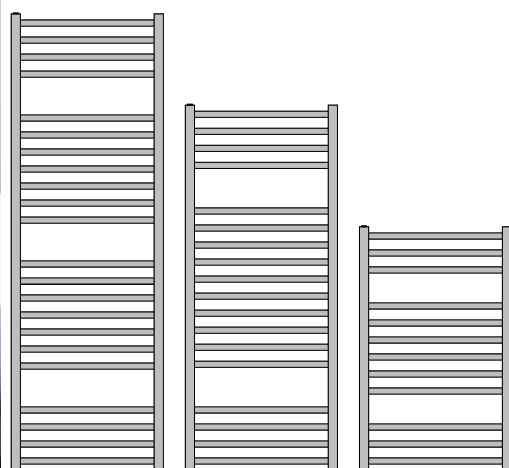

1500mm  
22 cross bars

1200mm  
18 cross bars

800mm  
12 cross bars



For electric element & valve options see pages 152 & 156



VL014

### Rubik

Tube diameter □	Dimensions (mm)			Bar Config	Pipe Centres	Electric element wattage	Output ΔT 50°C Watts/BTU's	Output ΔT 60°C BTU's	Stock or made to order
	H	W	D						
30sq + 20sq mm									
MD038	800	500	80	3-6-3	470	200	404 / 1378	1742	👤
MD038	1200	500	80	4-10-4	470	300	607 / 2071	2618	👤
MD038	1500	500	80	4-7-7-4	470	300	747 / 2549	3222	👤



Modern looks from this square tubed design brings together aesthetics and practicality. This versatile product will suit any modern bathroom. Chromed to a mirrored or anthracite finish. Prices shown are for central heating models.

# Squire

## Wall Mounted MD047



Anthracite Textured finish option

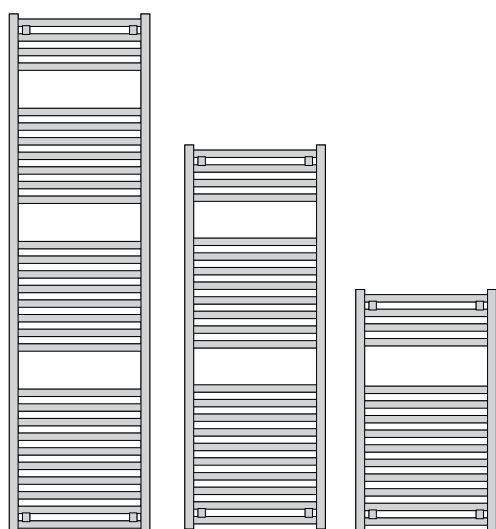

1770mm  
29 cross bars

1322mm  
22 cross bars

830mm  
14 cross bars



For electric element & valve options see pages 152 & 156



VL014

### Squire

Tube diameter 30sq + 25sq mm	Dimensions (mm)			Bar Config	Pipe Centres	Electric element wattage	Output ΔT 50°C Watts/BTU's		Output ΔT 60°C Watts		Stock or made to order
	H	W	D				chrome	painted	chrome	painted	
MD047	830	480	90	4-10	450	150	278 / 949	416 / 1419	1199	1794	✓
MD047	830	580	90	4-10	550	200	331 / 1129	495 / 1689	1428	2135	✓
MD047	1322	480	90	4-8-10	450	300	440 / 1501	656 / 2238	1898	2829	✓
MD047	1322	580	90	4-8-10	550	300	523 / 1784	780 / 2661	2256	3364	✓
MD047	1770	480	90	4-7-8-10	450	400	581 / 1982	868 / 2962	2506	3743	✓
MD047	1770	580	90	4-7-8-10	550	600	691 / 2358	1032 / 3521	2980	4451	✓

# Serene

## Wall Mounted MD049

The Serene is just that. A well balanced design which maximises hanging space. A perfect towel warmer for contemporary kitchens and bathrooms alike. Square tubes finished with a choice of chrome or contemporary finishes. Please see page 158 for colour options.

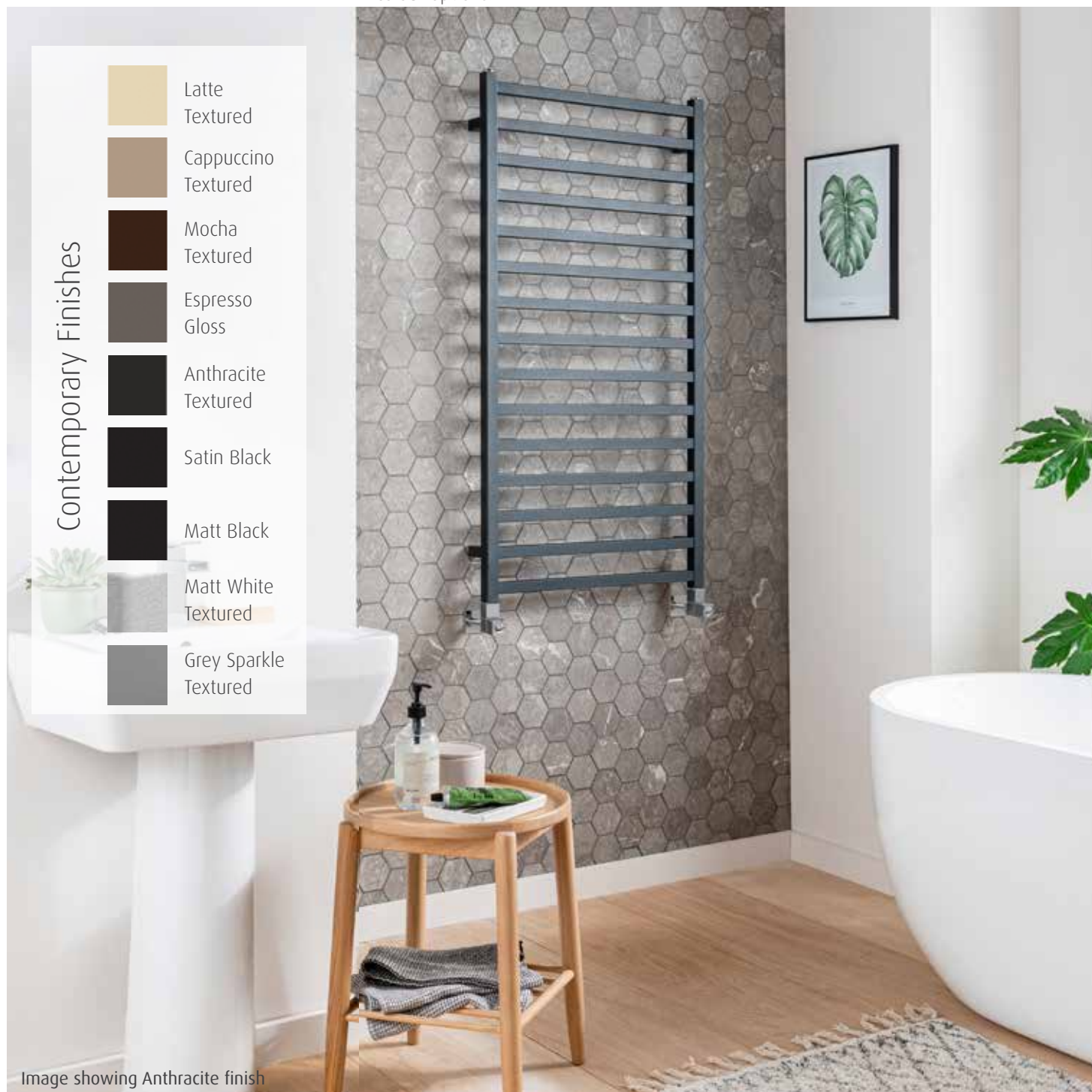







Image showing Anthracite finish

Prices shown are for central heating models.



For electric element & valve options see pages 152 & 156  VL014

### Serene

Tube diameter □ 25sq + 30sq mm	Dimensions (mm)			Bar Config	Pipe Centres	Electric element watt-age	Output ΔT 50°C Watts/BTU's		Output ΔT 60°C BTU's		Stock or made to order
	H	W	D				chrome	painted	chrome	painted	
MD049	1000	500	85	12	470	150	257 / 877	409 / 1396	1108	1764	
MD049	1165	500	85	15	470	200	314 / 1071	420 / 1433	1354	1811	
MD049	1165	600	85	15	570	300	365 / 1245	437 / 1491	1574	1885	
MD049	1700	500	85	20	470	300	434 / 1481	501 / 1709	1872	2161	
MD049	1700	600	85	20	570	400	520 / 1774	601 / 2051	2243	2592	

A contemporary, minimalist design with crisp edges and clean lines. The Ideal is manufactured in high quality stainless steel which is polished to perfection. Stainless steel construction is suitable for all hot water systems.

# Ideal

## Wall Mounted MD055



For electric element & valve options see pages 152 & 156



### Ideal

Tube diameter □ 30sq + 20sq mm	Dimensions (mm)			Bar Config	Pipe Centres	Electric element wattage	Output ΔT 50°C Watts/BTU's	Output ΔT 60°C BTU's	Stock or made to order
	H	W	D						
MD055	900	500	100	3-3	470	100	281 / 959	1212	✓
MD055	1200	500	100	4-4	470	125	375 / 1280	1617	✓
MD055	1500	500	100	5-5	470	150	469 / 1600	2023	✓

# Boxa

## Wall Mounted CN009

Boxa is crafted using large gauge square and rectangular tubing with smooth rounded corners. A perfect blend of form and function. There are two options, polished stainless steel or chromed mild steel. Available in three heights to suit the size of your room.



VL014

For electric element & valve options see pages 152 & 156

Prices shown are for chrome and polished stainless steel models. Please see pages 158 & 159 for finishes and colour options.



### Boxa - MS

Tube diameter □ 40sq x 40 + 20sq mm	Dimensions (mm)			Bar Config	Pipe Centres	Electric element wattage	Output ΔT 50°C Watts/BTU's	Output ΔT 60°C BTU's	Stock or made to order
	H	W	D						
CN009A - MS	620	450	120	3	410	100	199 / 679	858	✓
CN009B - MS	1060	450	120	5	410	150	290 / 989	1251	✓
CN009C - MS	1500	450	120	7	410	200	437 / 1491	1885	✓



### Boxa - SS

Tube diameter □ 40sq x 40 + 20sq mm	Dimensions (mm)			Bar Config	Pipe Centres	Electric element wattage	Output ΔT 50°C Watts/BTU's	Output ΔT 60°C BTU's	Stock or made to order
	H	W	D						
CN009A - SS	620	450	120	3	410	100	199 / 679	858	✘
CN009B - SS	1060	450	120	5	410	125	290 / 989	1251	✘
CN009C - SS	1500	450	120	7	410	200	437 / 1491	1885	✘

Arc has it all, ample towel hanging space and good heat output. Available in chrome to suit your ideal kitchen or bathroom. Manufactured from high quality mild steel. Prices shown are for central heating models in a chrome finish.

# Arc

## Wall Mounted MD065



Aerial view

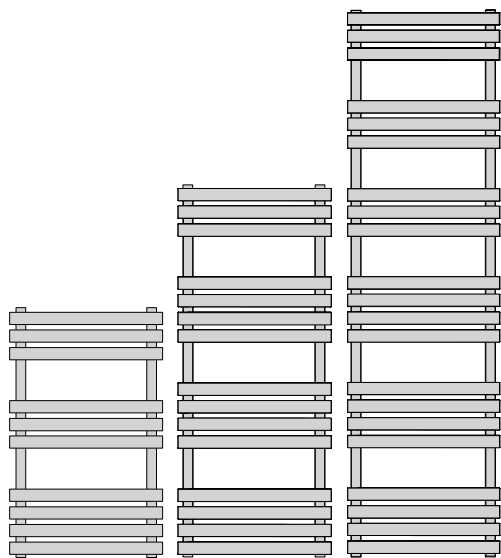

828mm 10 cross bars  
1200mm 15 cross bars  
1800mm 21 cross bars



For electric element & valve options see pages 152 & 156



VL014

Arc

Tube diameter ∅ 32mm 40 x 18mm	Dimensions (mm)			Bar Config	Pipe Centres	Electric element wattage	Output ΔT 50°C Watts/BTU's	Output ΔT 60°C BTU's	Stock or made to order
	H	W	D						
MD065	828	500	95	3-3-4	430	150	232 / 792	1001	✓
MD065	1200	500	95	3-4-4-4	430	300	346 / 1181	1492	✓
MD065	1800	500	95	3-3-3-4-4-4	430	400	491 / 1675	2118	✓

Sales: +44 (0) 1902 387000 | 37

# Gallant

## Wall Mounted MD040SS

Crafted in high quality stainless steel the Gallant is a bold stylish piece offering crisp right angles to stunning effect. Available in two heights in polished stainless steel, suitable for all hot water systems. Please see page 158 for colour options.

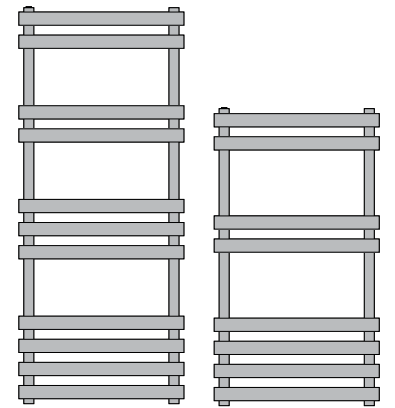

1200mm  
11 cross bars

900mm  
8 cross bars



For electric element & valve options see pages 152 & 156



### Gallant

Tube diameter □ 30sq + 40 x 20sq mm	Dimensions (mm)			Bar Config	Pipe Centres	Electric element wattage	Output ΔT 50°C Watts/BTU's	Output ΔT 60°C BTU's	Stock or made to order
	H	W	D						
MD040SS	900	500	97	2-2-4	440	200	458 / 1563	1975	👤
MD040SS	1200	500	97	2-2-3-4	440	300	624 / 2129	2691	👤

The square tubed design brings together aesthetics and practicality with a chromed a mirrored finish. This versatile product will suit any modern bathroom. Prices shown are for central heating models.

# Gallant II

Wall Mounted MD040MS

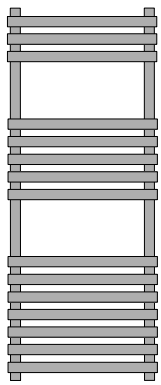

1270mm  
15 cross bars

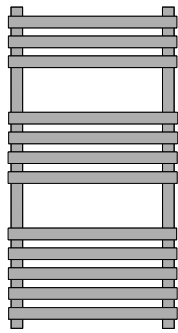

970mm  
12 cross bars



- MS
- 15
- C
- D
- E

For electric element & valve options see pages 152 & 156



## Gallant II

Tube diameter		Dimensions (mm)			Bar Config	Pipe Centres	Electric element wattage	Output $\Delta T$ 50°C Watts/BTU's	Output $\Delta T$ 60°C BTU's	Stock or made to order
$\varnothing$ 35mm	$\square$ 35 x 20mm	H	W	D						
		970	500	132	3-4-5	450	200	296 / 1010	1277	✓
		1270	500	132	3-5-7	450	300	363 / 1239	1566	✓

# Aquila

## Wall Mounted DR016

Rectangular tube towel rail provides ample space and heat for warming or drying towels, in a design which allows you to slide them effortlessly into place from either the left or right, depending on your preference. Manufactured from high quality mild steel.



Prices shown are chrome finished for central heating models.



For electric element & valve options see pages 152 & 156



### Aquila

Tube diameter □ 40 x 10 + 30 x 30mm	Dimensions (mm)			Bar Config	Pipe Centres	Electric element wattage	Output ΔT 50°C Watts/BTU's	Output ΔT 60°C BTU's	Stock or made to order
	H	W	D						
DR016	1200	500	118	3-3-3-3-3	60	150	354 / 1208	1527	✓
DR016	1400	600	118	3-3-3-3-3-3	60	200	436 / 1488	1880	✓



Asymmetric rectangular tube towel rails give a fascinating design that has clean lines and simple access from either side. Manufactured from high quality mild steel, prices shown are chrome finished for central heating models.

# Phoenix

## Wall Mounted DR017



- MS
- 15
- C
- D
- E
- 

For electric element & valve options see pages 152 & 156



### Phoenix

Tube diameter 40 x 10 + 30 x 30mm	Dimensions (mm)			Bar Config	Pipe Centres	Electric element wattage	Output $\Delta T$ 50°C Watts/BTU's	Output $\Delta T$ 60°C BTU's	Stock or made to order
	H	W	D						
DR017	1200	500	118	3-3-3-3-3	60	150	301 / 1027	1298	✓

# Curvee

## Wall Mounted MD050

Curvee is stylish and practical. As the name suggests, the cross rails are gently bowed. The towel rail offers good heat output in four sizes, the 800mm version is pictured. Available in chrome or white finish. Please see page 158 for colour options.

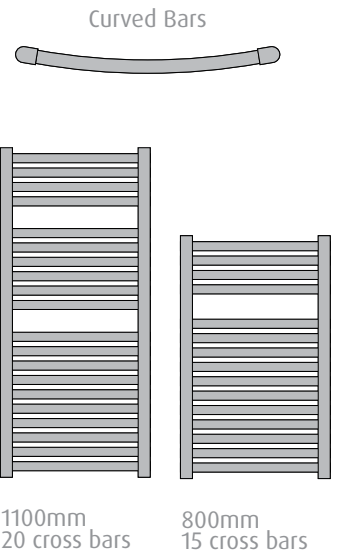

Prices shown are chrome finished for central heating models.



For electric element & valve options see pages 152 & 156



### Curvee

Tube diameter ∅ 15 x 30 + 30 x 40mm	Dimensions (mm)			Bar Config	Pipe Centres	Electric element watt- age	Output ΔT 50°C Watts/BTU's		Output ΔT 60°C BTU's		Stock or made to order
	H	W	D				chrome	paintd	chrome	paintd	
MD050	800	500	96	4-11	455	125	235 / 802	543 / 1853	1014	2342	✓
MD050	800	600	96	4-11	555	150	274 / 935	556 / 1897	1182	2398	✓
MD050	1100	500	96	4-6-10	455	200	316 / 1078	583 / 1989	1363	2514	✓
MD050	1100	600	96	4-6-10	555	300	387 / 1320	587 / 2003	1669	2532	✓

Rectangular crossbars give a solid feel to this design. Available in two sizes finished in your choice of chrome, white or a contemporary colour. Prices shown are for central heating models. Please see page 158 for colour options.

# Vela

## Wall Mounted MD048

### Contemporary Finishes

-   Latte Textured
-   Cappuccino Textured
-   Mocha Textured
-   Espresso Gloss
-   Anthracite Textured
-   Satin Black
-   Matt Black
-   Matt White Textured
-   Grey Sparkle Textured

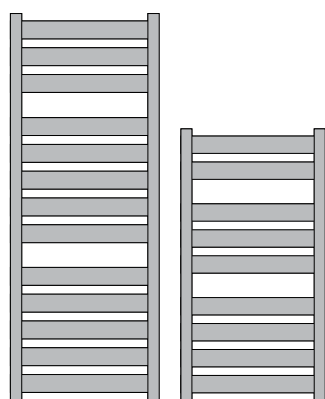

1300mm  
13 cross bars

950mm  
9 cross bars





- MS
- 15
- C
- D
- E
- 

For electric element & valve options see pages 152 & 156



### Vela

Tube diameter Ø 38mm □ 60 x 10mm	Dimensions (mm)			Bar Config	Pipe Centres	Electric element watt-age	Output ΔT 50°C Watts/BTU's		Output ΔT 60°C BTU's		Stock or made to order
	H	W	D				chrome	paint	chrome	paint	
MD048	950	500	101	2-3-4	462	125	246 / 839	289 / 986	1061	1246	
MD048	1300	500	101	3-5-5	462	200	330 / 1126	389 / 1327	1423	1678	

Sales: +44 (0) 1902 387000 | 43

# Décor

A memorable design, available in two sizes. Suitable for any modern bathroom. Chromed to a mirror finish. Prices shown are for central heating models.

## Wall Mounted MD084



For valve options see page 156 VL003

### Décor

Tube diameter ∅ 40 x 20 + 40 x 10mm	Dimensions (mm)			Bar Config	Face to Face connections	Output ΔT 50°C Watts/BTU's	Output ΔT 60°C BTU's	Stock or made to order
	H	W	D					
MD084	750	450	145	4	388	129 / 440	556	✓
MD084	1200	450	145	6	388	199 / 679	858	✓

Our Décor Harmonique is a style combination towel warmer, with flat horizontal bars and a contemporary. It is designed for high heat output. Its modern sleek look brings an air of sophistication to any setting.

# Décor Harmonique

Wall Mounted MD094



Manufactured from high quality mild steel in a chrome finish. Prices shown are chrome finish for central heating models. Please Note: Colour option only applies to the inset radiator, not the frame.



For electric element & valve options see pages 152 & 156



## Décor Harmonique

Tube diameter 40 x 20 + 40 x 10mm	Dimensions (mm)			Bar Config	Face to Face connections	Electric Element Wattage	Output $\Delta T$ 50°C Watts/BTU's	Output $\Delta T$ 60°C BTU's	Stock or made to order
	H	W	D						
MD094	1200	500	159	4	442	200	842 / 2873	3631	✓

Sales: +44 (0) 1902 387000 | 45

# Unique

## Wall Mounted CN028

Contemporary Towel Warmer with cylindrical features. Made from high quality mild steel. Prices shown are chrome finished for central heating models.



For electric element & valve options see pages 152 & 156



### Unique

Tube diameter	Dimensions (mm)			Bar Config	Pipe centres	Electric Element Wattage	Output $\Delta T$ 50°C Watts/BTU's	Output $\Delta T$ 60°C BTU's	Stock or made to order
	H	W	D						
$\varnothing$ 25.4mm									
CN028	950	500	90	4	460	125	155 / 529	668	✓

Venture is available in three widths and four heights, with spacious hanging bars. The bold jointed design suits contemporary interiors. Manufactured from high quality brass, chromed to a mirror finish. Please see pages 158 & 159 for finishes and colour options.

# Venture

## Wall Mounted CN022



Romolo Joint



VL003

For electric element & valve options see pages 152 & 156



### Venture

Tube diameter Ø 25.4 + 22mm	Dimensions (mm)			Bar Config	Pipe centres	Electric Element Wattage	Output ΔT 50°C Watts/BTU's	Output ΔT 60°C BTU's	Stock or made to order
	H	W	D						
CN022	750	450	95	4	400	75	121 / 413	522	✓
CN022	850	650	95	4	600	100	157 / 536	677	✎
CN022	1300	500	95	6	450	125	206 / 703	888	✎
CN022	1300	650	95	6	600	125	240 / 819	1035	✎
CN022	1600	500	95	8	450	150	267 / 911	1152	✎
CN022	1600	650	95	8	600	150	312 / 1065	1346	✎

# Vivid

## Wall Mounted CN021

Vivid is a beautiful minimalistic towel warmer, manufactured from high quality brass. Prices shown are for chrome heating and hot water systems. Please see pages 158 & 159 for finishes and colour options.



Mitred Joint



For electric element & valve options see pages 152 & 156



VL003

### Vivid

Tube diameter Ø 25.4 + 22mm	Dimensions (mm)			Bar Config	Pipe centres	Electric Element Wattage	Output ΔT 50°C Watts/BTU's	Output ΔT 60°C BTU's	Stock or made to order
	H	W	D						
CN021	750	450	93	4	400	75	121 / 413	522	✓
CN021	800	650	93	4	600	100	154 / 525	664	✎
CN021	1250	500	93	6	450	125	201 / 686	867	✓
CN021	1250	650	93	6	600	125	235 / 802	1014	✎
CN021	1550	500	93	8	450	150	258 / 880	1113	✎
CN021	1550	650	93	8	600	150	303 / 1034	1307	✎



Vivid II is a simplistic alternative to our Vivid without the mitred corner joints manufactured from high quality brass. Prices shown are for chrome heating and hot water systems.

# Vivid II

## Wall Mounted CN029



Please see pages 158 & 159 for finishes and colour options.



For electric element & valve options see pages 152 & 156



### Vivid II

Tube diameter ∅ 25.4mm	Dimensions (mm)			Bar Config	Pipe centres	Electric Element Wattage	Output ΔT 50°C Watts/BTU's	Output ΔT 60°C BTU's	Stock or made to order
	H	W	D						
CN029	700	500	94	4	450	75	138 / 471	595	
CN029	1100	500	94	5	450	125	189 / 645	815	
CN029	1400	500	94	6	450	150	232 / 792	1001	

# Vivid Integral Valve

## Wall Mounted IVCN021

Vivid IV has all the stunning looks of Vivid with the added feature of built in integral valves. Manufactured from high quality brass with a chrome mirror finish.

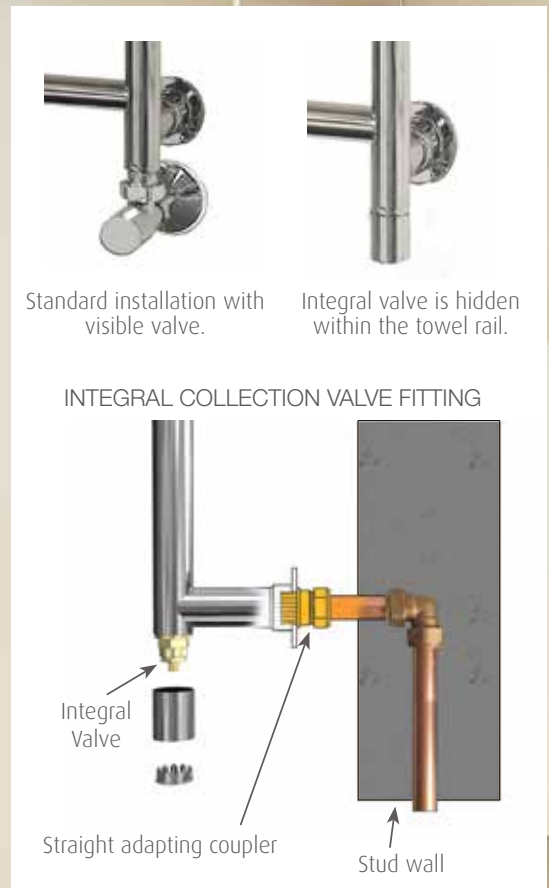

Prices shown are for chrome heating and hot water systems. This radiator is also available on previous page with standard valves. Please see pages 158 & 159 for finishes and colour options. Pipe work is hidden in the wall. We recommend using service valves as part of the installation. Please consult your installer for the suitability of a brick wall installation.



### Vivid Integral Valve

Tube diameter ∅ 25.4mm	Dimensions (mm)			Bar Config	Pipe centres	Output ΔT 50°C Watts/BTU's	Output ΔT 60°C BTU's	Stock or made to order
	H	W	D					
IVCN021	700	500	94	4	450	138 / 471	595	👉
IVCN021	1100	500	94	5	450	189 / 645	815	👉
IVCN021	1400	500	94	6	450	232 / 792	1001	👉

Simple and beautiful, this design manufactured from high quality brass, is perfect at the side of a shower.

# Simplicity Integral Valve

Wall Mounted IVCN026



Prices shown are chrome finished for all heating and hot water systems. Please see pages 158 & 159 for finishes and colour options. Pipe work is hidden in the wall. We recommend using service valves as part of the installation. Not suitable for brick walls.



## Simplicity Integral Valve

Tube diameter	Dimensions (mm)			Bar Config	Pipe centres	Output $\Delta T$ 50°C Watts/BTU's	Output $\Delta T$ 60°C BTU's	Stock or made to order
	H	W	D					
$\varnothing$ 25.4mm								
IVCN026	1700	50	115	1	1625	75 / 256	323	

# Vivid Integral Valve

Wall Mounted IVCN021

Vivid IV horizontal is the ideal choice over a bath or underneath a window. The single bar versions are perfect for en-suites and small spaces. Manufactured from high quality brass with built in valves.



Image showing Polished Brass finish

Prices shown are chrome finished for all heating and hot water systems. Please see pages 158 & 159 for finishes and colour options. Pipe work is hidden in the wall. We recommend using service valves as part of the installation. Not suitable for brick walls.



## Vivid Integral Valve

Tube diameter Ø 25.4mm	Dimensions (mm)			Bar Config	Pipe centres	Output ΔT 50°C Watts/BTU's	Output ΔT 60°C BTU's	Stock or made to order
	H	W	D					
IVCN021 single bar	50	400	94	1	325	21 / 72	91	
IVCN021 single bar	50	600	94	1	525	30 / 102	129	

Vivid IV 3 bar version for additional towel drying capacity. Manufactured from high quality brass with built in integral valves.

# Vivid Integral Valve

Wall Mounted IVCN021



Prices shown are chrome finished for all heating and hot water systems. Please see pages 158 & 159 for finishes and colour options. Pipe work is hidden in the wall. We recommend using service valves as part of the installation. Not suitable for brick walls.



## Vivid Integral Valve

	Tube diameter	Dimensions (mm)			Bar Config	Pipe centres	Output ΔT 50°C Watts/BTU's	Output ΔT 60°C BTU's	Stock or made to order
	∅ 25.4mm	H	W	D					
IVCN021		400	1200	94	3	1150	183 / 624	789	

# Ieri

## Wall Mounted TM014 - MS

An alternative mild steel option to the Ieri brass model, offering a fixed shelf position for the added benefit of towel stacking or towel hanging space. Available in two height options to suit your space.



Manufactured from high quality mild steel. Prices shown are chrome finished for central heating models.



For electric element & valve options see pages 152 & 156



### Ieri - MS

Tube diameter Ø 32 + 25 + 19mm	Dimensions (mm)			Bar Config	Pipe Centres	Electric element wattage	Output ΔT 50°C Watts/BTU's	Output ΔT 60°C BTU's	Stock or made to order
	H	W	D						
TM014-MS	750	525	265	5	240	100	173 / 590	746	✓
TM014-MS	1350	525	265	8	240	200	277 / 945	1195	✓

The integrated shelf in this curvaceous design has the added benefit of towel stacking as well as plentiful hanging space. Available in two height options to suit your space with an alternative shelf position which is optional on point of order.

Ieri

Wall Mounted TM014 - BR



Please note shelf location may vary when electric model specified on Brass model

Manufactured from high quality brass and chrome finished, with bespoke finishes available at an additional cost. Please see pages 158 & 159 for finishes and colour options. Prices shown are chrome finished for central heating models.



For electric element & valve options see pages 152 & 156



VL003

### Ieri - BR

Tube diameter Ø 25.4 + 22mm	Dimensions (mm)			Bar Config	Face to Face connections	Electric element wattage	Output ΔT 50°C Watts/BTU's	Output ΔT 60°C BTU's	Stock or made to order
	H	W	D						
TM014	750	500	265	4	375	100	219 / 747	944	
TM014	1350	500	265	7	375	200	329 / 1123	1419	

# Solo

The single shelf towel rack, Solo is an ideal design for limited space. This design provides ease of access to your dry and warm towels.

## Wall Mounted TR001



Manufactured from quality brass or mild steel and chromed to a mirror finish. Bespoke finishes are available at an additional cost. Please see page 158 for colour options. Prices shown are chrome finished for central heating models.



For electric element & valve options see pages 152 & 156



### Solo - MS

Tube diameter Ø 25.4mm	Dimensions (mm)			Bar Config	Pipe Centres	Electric element wattage	Output ΔT 50°C Watts/BTU's	Output ΔT 60°C BTU's	Stock or made to order
	H	W	D						
TR001-MS	265	500	315	5	425	50	97 / 331	418	✓



### Solo - BR

Tube diameter Ø 25.4mm	Dimensions (mm)			Bar Config	Pipe Centres	Electric element wattage	Output ΔT 50°C Watts/BTU's	Output ΔT 60°C BTU's	Stock or made to order
	H	W	D						
TR001	263	500	315	5	425	50	126 / 430	543	✘



The double shelf towel rack Binary, is perfect for situations where space is at a premium and style is of priority. This clever design allows you to stack, roll or hang your towels, so they are always warm, dry and handy.

# Binary

## Wall Mounted TR002

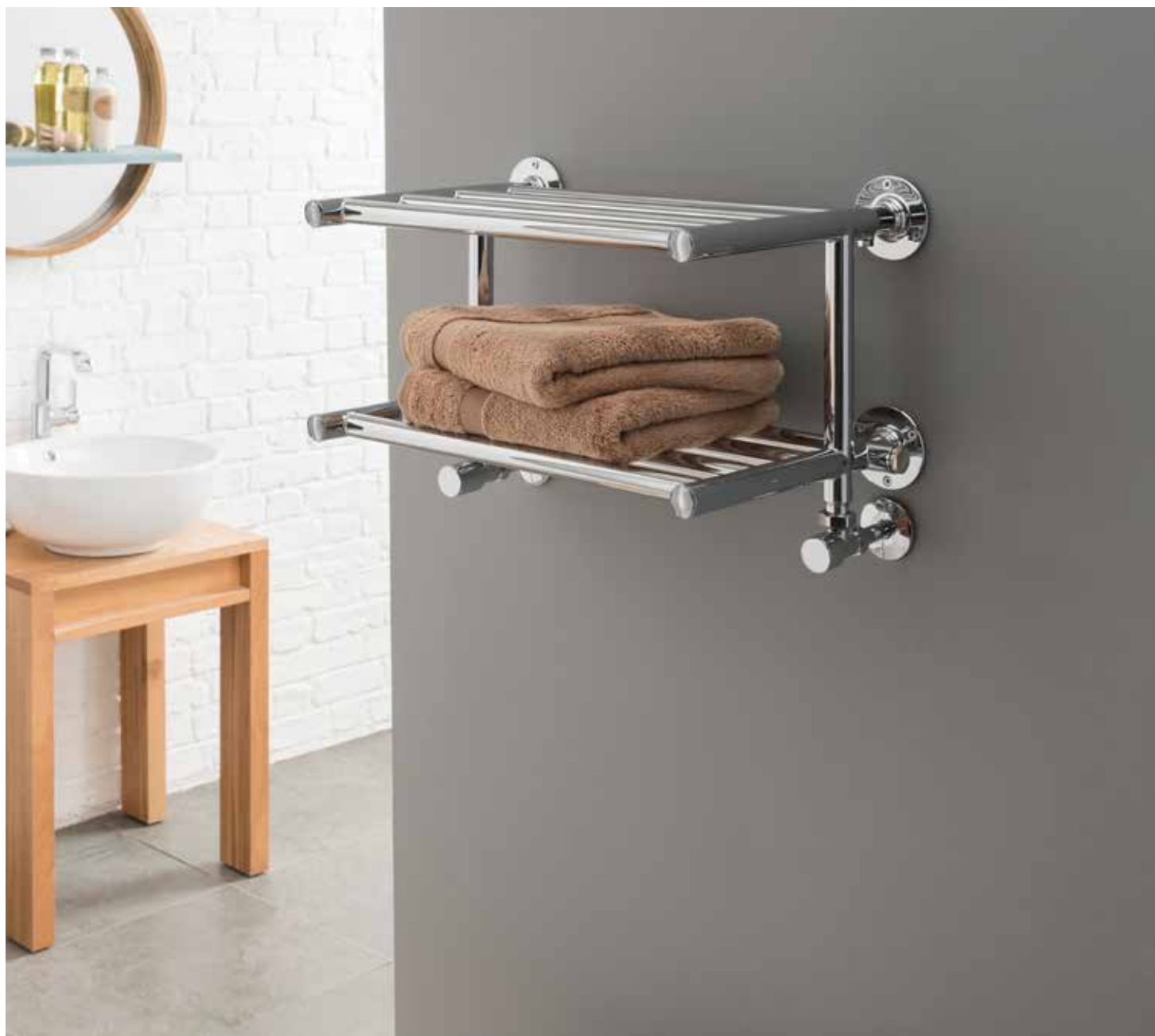

Manufactured from quality brass or mild steel and chromed to a mirror finish. Bespoke finishes are available at an additional cost. Please see page 158 for colour options. Prices shown are chrome finished for central heating models.

For electric element & valve options see pages 152 & 156



### Binary MS

Tube diameter Ø 25.4mm	Dimensions (mm)			Bar Config	Pipe Centres	Electric element wattage	Output ΔT 50°C Watts/BTU's	Output ΔT 60°C BTU's	Stock or made to order
	H	W	D						
TR002-MS	274	500	315	9	425	75	155 / 529	668	✓



### Binary BR

Tube diameter Ø 25.4mm	Dimensions (mm)			Bar Config	Pipe Centres	Electric element wattage	Output ΔT 50°C Watts/BTU's	Output ΔT 60°C BTU's	Stock or made to order
	H	W	D						
TR002	275	500	315	9	425	75	224 / 764	966	✎

# Comby

## Wall Mounted MD052

Comby is designed to provide completely adaptable towel hanging and storage space. Towels in use can be hung over the cross rails to dry, clean towels placed on the folding shelf. Chromed to a mirror or white painted finish. Prices shown are for central heating models.



The Comby is designed for efficient heating of your towels and will provide maximum heat output with the shelf in the open position (as illustrated). In the closed (down) position heating of the shelf is reduced.

MS 15 C

For valve options see page 156  VL003

### Comby

Tube diameter 40 x 30 D Section + 22mm	Dimensions (mm)			Bar Config	Pipe Centres	Output $\Delta T$ 50°C Watts/BTU's		Output $\Delta T$ 60°C BTU's		Stock or made to order
	H	W	D			Chrome	White	Chrome	White	
MD052	1200	500	85-110	25	455	377 / 1286	507 / 1730	1626	2187	✓
MD052	1200	600	85-110	25	555	452 / 1542	683 / 2330	1949	2946	✓

A modern chrome multi-rail towel warmer with folding shelf combined with a white double panel radiator giving high heat output and drying in a combined unit. Inset radiator available in other radiator RAL colours.

# Harmonique Duo

Wall Mounted MD090



The Harmonique Duo is designed for efficient heating of your towels and will provide maximum heat output with the shelf in the open position (as illustrated). In the closed (down) position heating of the shelf is reduced. Manufactured from mild steel, suitable for closed heating systems. Please see page 158 for colour options. Please Note: Colour option only applies to the inset radiator, not the frame.



For valve options see page 156 VL003

## Harmonique Duo

Tube diameter Ø 40 x 30 D Section + 22mm	Dimensions (mm)			Bar Config	Pipe Centres	Output ΔT 50°C Watts/BTU's	Output ΔT 60°C BTU's	Stock or made to order
	H	W	D					
MD090	1200	500	104	25	455	850 / 2900	3666	✓
MD090	1200	600	104	25	555	1170 / 3992	5046	✓

# Carina

## Wall Mounted MD051

Carina offers curves that work perfectly with the bold tubular design. The towel rail maximises storage space with a top shelf. Finished in chrome to match your sanitary-ware. Style and versatility for the most contemporary of settings. Manufactured from high quality mild steel.



Prices shown are chrome finished for central heating models.



For electric element & valve options see pages 152 & 156



### Carina

Tube diameter ∅ 22 + 40 x 30mm D Section	Dimensions (mm)			Bar Config	Face to Face connections	Electric element wattage	Output ΔT 50°C Watts/BTU's	Output ΔT 60°C BTU's	Stock or made to order
	H	W	D						
MD051	1200	500	225	8	422	125	223 / 761	962	✓
MD051	1200	600	225	8	522	150	243 / 829	1048	✓

A perfect combination for heating and drying. This versatile product will suit any modern bathroom. With a white double panelled radiator as standard and 25mm chrome horizontal tubes. Other radiator colours can be specified, please see page 158 for colour options.

# Harmonique

## Wall Mounted MD060

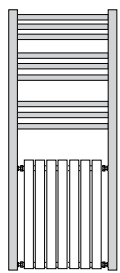

1200 x 500mm  
7 Sections

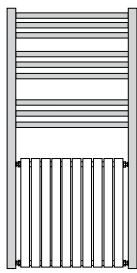

1200 x 600mm  
10 Sections

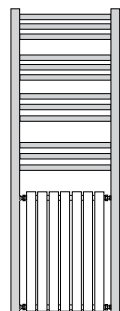

1500 x 500mm  
7 Sections

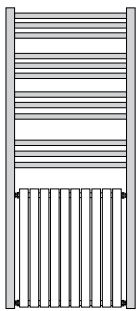

1500 x 600mm  
10 Sections



Prices shown are for central heating models. Please Note: Colour option only applies to the inset radiator, not the frame.



For electric element & valve options see pages 152 & 156



### Harmonique

Tube diameter ∅ 25 + 30 x 40mm D Section	Dimensions (mm)			Bar Config	Pipe Centres	Electric element wattage	Output ΔT 50°C Watts/BTU's	Output ΔT 60°C BTU's	Stock or made to order
	H	W	D						
MD060	1200	500	93	3-3-3	464	300	834 / 2846	3597	✓
MD060	1200	600	93	3-3-3	564	400	1033 / 3525	4455	✓
MD060	1500	500	93	3-3-3-3	464	400	1145 / 3907	4938	✓
MD060	1500	600	93	3-3-3-3	564	400	1438 / 4906	6202	✓

# Nexus III

## Wall Mounted TM001

High heat output from a radiator combined with a stylish brass frame makes the perfect combination of heat, good looks and versatility to enhance any bathroom or utility room. Prices shown are for central heating models. The inset radiator comes in white as standard.



Please see pages 158 & 159 for finishes and colour options applicable to the tubular frame only.

Please Note: The colour option does not apply to the inset radiator.



For electric element & valve options see pages 152 & 156



### Nexus III

Tube diameter ∅ 25.4 + 15mm	Dimensions (mm)			Bar Config	Pipe Centres	Electric element wattage	Output ΔT 50°C Watts/BTU's	Output ΔT 60°C BTU's	Stock or made to order
	H	W	D						
TM001	900	525	142	6	500	400	716 / 2443	3088	

The contemporary version of the Nexus Grand is manufactured in brass framework and chrome finished. Prices shown are for central heating models. The inset radiator comes in white as standard.

# Nexus IV

## Wall Mounted TM002



Please see pages 158 & 159 for finishes and colour options applicable to the tubular frame only.  
Please Note: The colour option does not apply to the inset radiator.



For electric element & valve options see pages 152 & 156



### Nexus IV

	Tube diameter	Dimensions (mm)			Bar Config	Pipe Centres	Electric element wattage	Output $\Delta T$ 50°C Watts/BTU's	Output $\Delta T$ 60°C BTU's	Stock or made to order
	$\varnothing$ 25.4 + 22mm	H	W	D						
TM002		900	590	214	3	500	400	689 / 2351	2971	

# Tempo

## Wall Mounted MD072

A contemporary multirail, with protruding bars for extra towel hanging space. Prices shown are chromed finish for central heating models.



MS 15 C D E

For electric element & valve options see pages 152 & 156



### Tempo

Tube diameter Ø 22 + 30 x 40mm D section	Dimensions (mm)			Bar Config	Pipe Centres	Electric element wattage	Output ΔT 50°C Watts/BTU's	Output ΔT 60°C BTU's	Stock or made to order
	H	W	D						
MD072	800	500	170-190	17 + 9	455	150	416 / 1419	1794	✓
MD072	1160	500	170-190	25 + 12	455	300	592 / 2020	2553	✓



A towel warmer providing great efficiency and easy to install with its lightweight material.  
Available in white or anthracite.

# Astute

## Wall Mounted CN095



AL 30 H D E

For electric element & valve options see pages 152 & 156



Astute

	Dimensions (mm)			Bar config	Pipe centres	Electric element wattage	Output $\Delta T$ 50°C Watts/BTU's	Output $\Delta T$ 60°C BTU's	Stock or made to order
	H	W	D						
095	1200	500	100	10	470	600	778 / 2655	3355	✓

Sales: +44 (0) 1902 387000 | 65

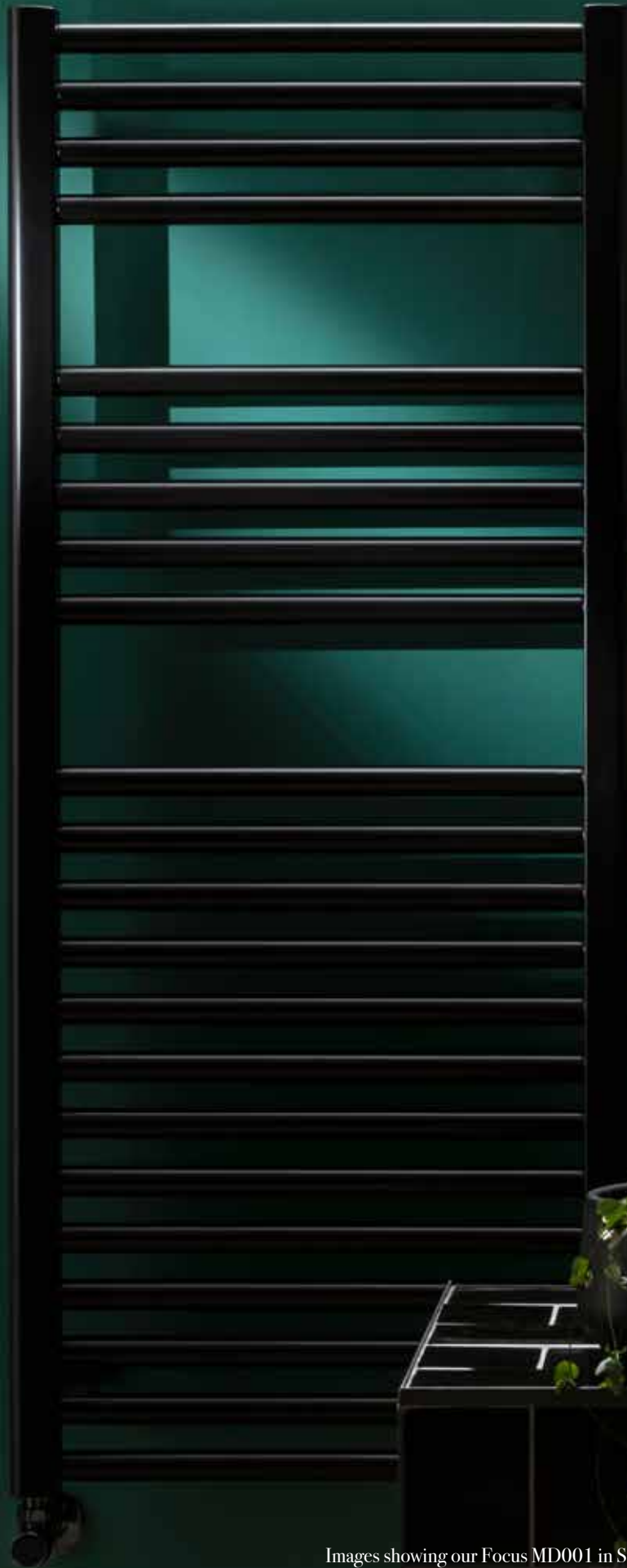

Images showing our Focus MD001 in Satin Black  
See page 75



## Ladder Rails

Who said being practical had to be boring?

Our range of ladder rails combine function and form effortlessly. Choose from our inspired range and heating your room and warming your towels need never be dull again.



# Axis

## 22mm Wall Mounted MD062

Our Axis has adjustable brackets through the crossbars, which offers freedom and ease of installation. The amount of rails are ideal for optimum efficiency. This contemporary rail is a modern example of proficient design. Prices shown are for chrome finish, central heating models.

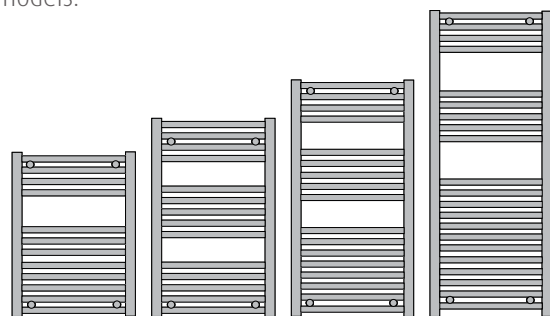

600mm 12 cross bars  
800mm 14 cross bars  
1000mm 17 cross bars  
1200mm 21 cross bars

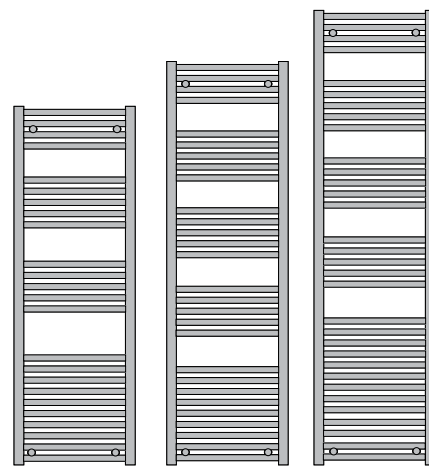

1400mm 24 cross bars  
1600mm 28 cross bars  
1800mm 32 cross bars

### Axis (Straight)

Tube diameter Ø 22 + 30 x 40mm D section	Dimensions (mm)			Bar Config	Pipe Centres	Electric element wattage	Output ΔT 50°C Watts/BTU's	Output ΔT 60°C BTU's	Stock or made to order
	H	W	D						
MD062	600	400	83 - 105	4-8	355	100	172 / 587	742	✓
MD062	600	500	83 - 105	4-8	455	125	208 / 710	897	✓
MD062	600	600	83 - 105	4-8	555	125	245 / 836	1057	✓
MD062	800	300	83 - 105	4-5-5	255	100	167 / 570	720	✓
MD062	800	400	83 - 105	4-5-5	355	100	209 / 713	901	✓
MD062	800	500	83 - 105	4-5-5	455	125	252 / 860	1087	✓
MD062	800	600	83 - 105	4-5-5	555	150	295 / 1007	1272	✓
MD062	800	750	83 - 105	4-5-5	705	200	359 / 1225	1548	✓
MD062	1000	300	83 - 105	4-5-8	255	150	204 / 696	880	✓
MD062	1000	400	83 - 105	4-5-8	355	150	256 / 873	1104	✓
MD062	1000	500	83 - 105	4-5-8	455	200	308 / 1051	1328	✓
MD062	1000	600	83 - 105	4-5-8	555	200	361 / 1232	1557	✓
MD062	1200	300	83 - 105	4-5-12	255	200	250 / 853	1078	✓
MD062	1200	400	83 - 105	4-5-12	355	200	313 / 1068	1350	✓
MD062	1200	500	83 - 105	4-5-12	455	200	378 / 1290	1630	✓
MD062	1200	600	83 - 105	4-5-12	555	300	443 / 1512	1911	✓
MD062	1200	750	83 - 105	4-5-12	705	300	537 / 1832	2316	✓
MD062	1400	500	83 - 105	4-5-5-10	455	300	431 / 1471	1859	✓
MD062	1400	600	83 - 105	4-5-5-10	555	300	504 / 1720	2174	✓
MD062	1600	400	83 - 105	4-5-5-5-9	355	300	412 / 1406	1777	✓
MD062	1600	500	83 - 105	4-5-5-5-9	455	300	495 / 1689	2135	✓
MD062	1600	600	83 - 105	4-5-5-5-9	555	400	580 / 1979	2501	✓
MD062	1800	400	83 - 105	4-5-5-5-13	355	400	464 / 1583	2001	✓
MD062	1800	500	83 - 105	4-5-5-5-13	455	400	558 / 1904	2407	✓
MD062	1800	600	83 - 105	4-5-5-5-13	555	400	654 / 2231	2821	✓
MD062	1800	750	83 - 105	4-5-5-5-13	705	400	815 / 2781	3515	✓

### Straight Bars



Optional Aroma Plug

Blanking Plug with Aroma Oil Dish  
AC035



VL003

For electric element & valve options see pages 152 & 156



Image showing Matt Black finish

MS 15 C D E

New for 2021

### Axis Matt Black (Straight)

	Dimensions (mm)			Bar Config	Pipe Centres	Electric element wattage	Output $\Delta T$ 50°C Watts/BTU's	Output $\Delta T$ 60°C BTU's	Stock or made to order
	H	W	D						
MD062	800	500	83 - 105	4-5-5	455	125	328 / 1119	1415	✓
MD062	800	600	83 - 105	4-5-5	555	150	384 / 1310	1656	✓
MD062	1200	500	83 - 105	4-5-12	455	200	492 / 1678	2122	✓
MD062	1200	600	83 - 105	4-5-12	555	300	576 / 1965	2484	✓
MD062	1600	500	83 - 105	4-5-5-5-9	455	300	644 / 2197	2777	✓
MD062	1600	600	83 - 105	4-5-5-5-9	555	400	754 / 2572	3252	✓

# Combes

## 22mm Wall Mounted MD063

Our Combes offers adjustable brackets through the crossbars also offer freedom and ease of installation. Offering a copious amount of rails for optimum efficiency, this contemporary rail is a modern example of proficient design. The curved version of our MD062. Prices shown are for chromed finish, central heating models.

Curved Bars

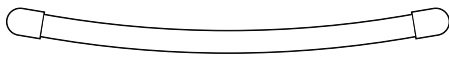

Optional Aroma Plug



Blanking Plug with Aroma Oil Dish  
AC035

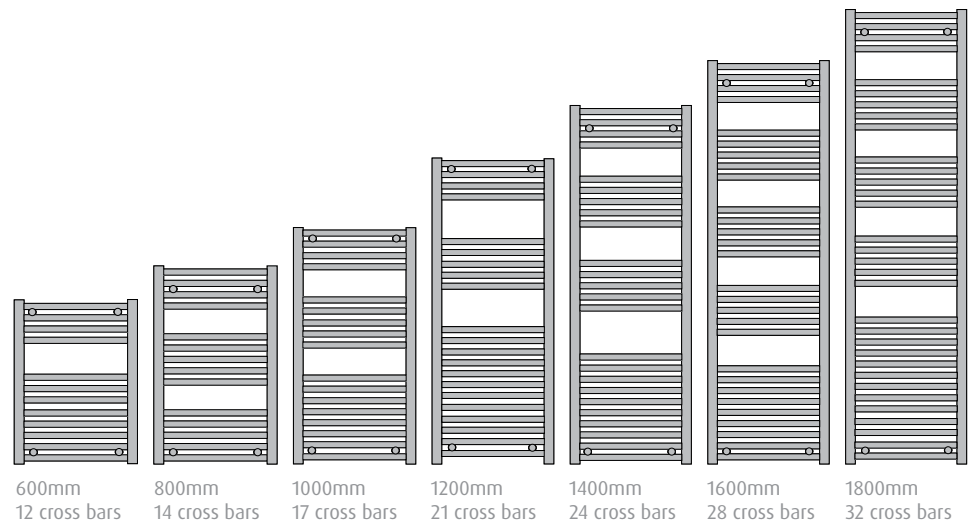

- MS
- 15
- C
- D
- E

For electric element & valve options see pages 152 & 156



### Combes (Curved)

Tube diameter ∅ 22 + 30 x 40mm D section	Dimensions (mm)			Bar Config	Pipe Centres	Electric element wattage	Output ΔT 50°C Watts/BTU's	Output ΔT 60°C BTU's	Stock or made to order
	H	W	D						
MD063	800	500	89 - 119	4-5-5	455	125	252 / 860	1087	✓
MD063	800	600	95 - 125	4-5-5	555	150	295 / 1007	1272	✓
MD063	1000	500	89 - 119	4-5-8	455	200	308 / 1051	1328	✓
MD063	1000	600	95 - 125	4-5-8	555	200	361 / 1232	1557	✓
MD063	1200	500	89 - 119	4-5-12	455	200	378 / 1290	1630	✓
MD063	1200	600	95 - 125	4-5-12	555	300	443 / 1512	1911	✓
MD063	1400	500	89 - 119	4-5-5-10	455	300	431 / 1471	1859	✓
MD063	1400	600	95 - 125	4-5-5-10	555	300	504 / 1720	2174	✓
MD063	1600	500	89 - 119	4-5-5-5-9	455	300	495 / 1689	2135	✓
MD063	1600	600	95 - 125	4-5-5-5-9	555	400	580 / 1979	2501	✓
MD063	1800	500	89 - 119	4-5-5-5-13	455	400	558 / 1904	2407	✓
MD063	1800	600	95 - 125	4-5-5-5-13	555	400	654 / 2231	2821	✓



# Focus

## 25mm Wall Mounted MD001

The Focus is a range of 25mm horizontal tube design towel warmers. Giving high heat output and superior looks. Manufactured from high quality mild steel with smooth flat tops and rear air vent. Prices shown are for chrome and white central heating models.



Image shown with VL015 valves

Straight Bars

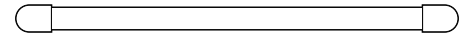

Available in other contemporary colours please see page 75. Please see page 158 for colour options.



For electric element & valve options see pages 152 & 156



### Focus (Straight)

Tube diameter 25 + 30 x 40mm D section	Dimensions (mm)			Bar Config	Pipe Centres	Electric element wattage	Output ΔT 50°C Watts/BTU's		Output ΔT 60°C BTU's		Stock or made to order
	H	W	D				chrome	white	chrome	white	
MD001	800	300	93-113	3-5-6	255	100	177 / 604	271 / 925	763	1169	✓
MD001	800	400	93-113	3-5-6	355	125	226 / 771	346 / 1181	975	1492	✓
MD001	800	500	93-113	3-5-6	455	150	275 / 938	420 / 1433	1186	1811	✓
MD001	800	600	93-113	3-5-6	555	200	324 / 1105	495 / 1689	1397	2135	✓
MD001	1000	500	93-113	4-5-9	455	200	351 / 1198	446 / 1522	1514	1923	✓
MD001	1000	600	93-113	4-5-9	555	200	414 / 1413	510 / 1740	1785	2200	✓
MD001	1200	300	93-113	4-5-13	255	200	273 / 931	424 / 1447	1177	1829	✓
MD001	1200	400	93-113	4-5-13	355	200	350 / 1194	543 / 1853	1509	2342	✓
MD001	1200	500	93-113	4-5-13	455	300	428 / 1460	663 / 2262	1846	2859	✓
MD001	1200	600	93-113	4-5-13	555	400	505 / 1723	783 / 2672	2178	3377	✓
MD001	1500	500	93-113	4-5-7-12	455	300	534 / 1822	820 / 2798	2303	3536	✓
MD001	1500	600	93-113	4-5-7-12	555	400	631 / 2153	969 / 3306	2721	4192	✓
MD001	1800	400	93-113	4-5-12-13	355	400	521 / 1778	793 / 2706	2247	3420	✓
MD001	1800	500	93-113	4-5-12-13	455	600	638 / 2177	969 / 3306	2752	4179	✓
MD001	1800	600	93-113	4-5-12-13	555	600	754 / 2573	1146 / 3910	3252	4942	✓



The curved version of the Focus. The Chorus has all the same attributes with high heat output and superb looks. Prices shown are for chrome or white central heating models. Please see page 158 for colour options.

# Chorus

## 25mm Wall Mounted MD002

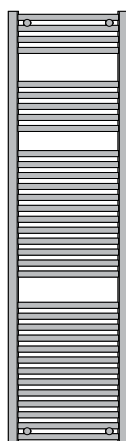
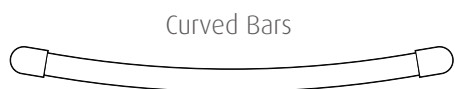

1800mm  
34 cross bars

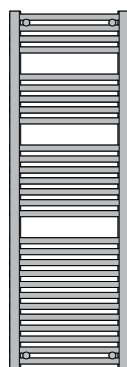

1500mm  
28 cross bars



Rear Air Vent

Capped off smooth ends for aesthetic appeal and ease of installation.

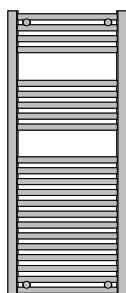

1200mm  
22 cross bars

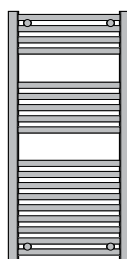

1000mm  
18 cross bars

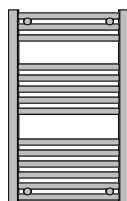

800mm  
14 cross bars



Image shown with VL015 valves



For electric element & valve options see pages 152 & 156



VL003

### Chorus (Curved)

Tube diameter ∅ 25 + 30 x 40mm D section	Dimensions (mm)			Bar Config	Pipe Centres	Electric element wattage	Output ΔT 50°C Watts/BTU's		Output ΔT 60°C BTU's		Stock or made to order
	H	W	D				chrome	white	chrome	white	
MD002	800	500	88-108	3-5-6	455	150	275 / 938	420 / 1433	1186	1811	✓
MD002	800	600	94-114	3-5-6	555	200	324 / 1105	495 / 1689	1397	2135	✓
MD002	1000	500	88-108	4-5-9	455	200	351 / 1198	-	1514	-	✓
MD002	1000	600	94-114	4-5-9	555	200	414 / 1413	-	1785	-	✓
MD002	1200	500	88-108	4-5-13	455	300	428 / 1460	663 / 2262	1846	2859	✓
MD002	1200	600	94-114	4-5-13	555	400	505 / 1723	783 / 2672	2178	3377	✓
MD002	1500	500	88-108	4-5-7-12	455	300	534 / 1822	820 / 2798	2303	3536	✓
MD002	1500	600	94-114	4-5-7-12	555	400	631 / 2153	969 / 3306	2721	4179	✓
MD002	1800	500	88-108	4-5-12-13	455	600	638 / 2177	969 / 3306	2752	4179	✓
MD002	1800	600	94-114	4-5-12-13	555	600	754 / 2573	1146 / 3910	3252	4942	✓

# Focus Horizontal

25mm Wall Mounted MD001H

Our Focus horizontal is a smart alternative to the typical ladder- rail style. Allowing you to hang towels side by side and a perfect fit for underneath a window or shelf, with high heat output and superb looks.



Prices shown are for chrome, White or Anthracite central heating models. Please see page 158 for colour options.

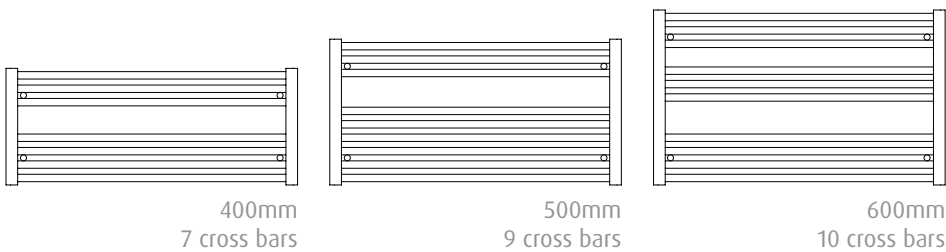

For electric element & valve options see pages 152 & 156

## Focus Horizontal

Please note painted models supplied with chrome brackets

Tube diameter ∅ 25 + 30 x 40mm D section	Dimensions (mm)			Bar Config	Pipe Centres	Electric element wattage	Output ΔT 50°C Watts/BTU's		Output ΔT 60°C BTU's		Stock or made to order
	H	W	D				chrome	Anthracite or White	chrome	Anthracite or White	
MD001H	400	1000	93-113	3-4	955	100	200 / 682	302 / 1030	863	1302	✓
MD001H	500	1000	93-113	3-6	955	125	256 / 873	386 / 1317	1104	1665	✓
MD001H	600	1000	93-113	3-3-4	955	150	288 / 983	434 / 1481	1242	1872	✓

Contemporary painted finishes in our popular 25mm horizontal tube multi-rail. Prices shown are for central heating models. Optional accessories available in different finishes.

# Focus Colours

## 25mm Wall Mounted MD001

### Contemporary Finishes

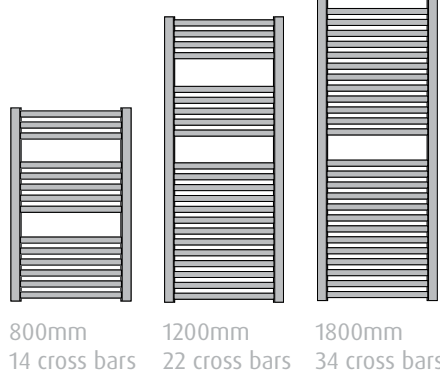

Image showing Satin Black finish

**New sizes for 2021**  
800 x 400 & 1500 x 500



Painted colour options available in our popular Arne (VL003) valves.

For electric element & valve options see pages 152 & 156



### Focus Colours

Tube diameter 25 + 30 x 40mm D section	Dimensions (mm)			Bar Config	Pipe Centres	Electric element wattage	Output ΔT 50°C Watts/BTU's	Output ΔT 60°C BTU's	Stock or made to order
	H	W	D						
MD001	800	400	93	3-5-6	355	125	346 / 1181	1493	✓
MD001	800	500	93	3-5-6	455	150	420 / 1433	1811	✓
MD001	1200	300	93	4-5-13	255	200	424 / 1447	1829	✓
MD001	1200	500	93	4-5-13	455	300	663 / 2262	2859	✓
MD001	1200	600	93	4-5-13	555	400	783 / 2672	3377	✓
MD001	1500	500	93	4-5-7-12	455	300	820 / 2798	3537	✓
MD001	1800	500	93	4-5-12-13	455	600	969 / 3306	4179	✓

# Chube

## Stainless Steel MD035

The round tube polished stainless steel design with rear air vent, brings together aesthetics and practicality. It will suit any modern bathroom. Please see page 158 for colour options. Stainless Steel suitable for all hot water systems.

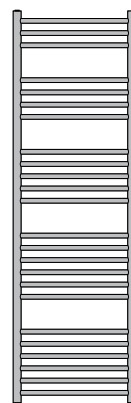

1600mm  
24 Cross Bars

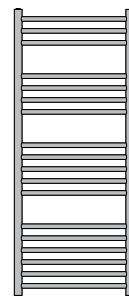

1200mm  
18 Cross Bars

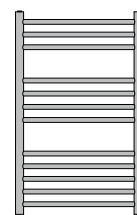

800mm  
12 Cross Bars



For electric element & valve options see pages 152 & 156

VL003



### Chube

Tube diameter Ø 31.8 + 22mm	Dimensions (mm)			Bar Config	Pipe Centres	Electric element wattage	Output ΔT 50°C Watts/BTU's	Output ΔT 60°C BTU's	Stock or made to order
	H	W	D						
MD035	800	300	100	3-4-5	268	100	161 / 549	694	✓
MD035	800	400	100	3-4-5	368	100	197 / 672	850	✓
MD035	800	500	100	3-4-5	468	125	243 / 829	1048	✓
MD035	800	600	100	3-4-5	568	150	269 / 918	1160	✓
MD035	1200	300	100	3-4-5-6	268	125	240 / 819	1035	✓
MD035	1200	400	100	3-4-5-6	368	150	294 / 1003	1268	✓
MD035	1200	500	100	3-4-5-6	468	200	348 / 1187	1501	✓
MD035	1200	600	100	3-4-5-6	568	200	402 / 1372	1734	✓
MD035	1600	300	100	3-4-5-6-6	268	200	321 / 1095	1384	✓
MD035	1600	400	100	3-4-5-6-6	368	200	391 / 1334	1686	✓
MD035	1600	500	100	3-4-5-6-6	468	300	464 / 1583	2001	✓
MD035	1600	600	100	3-4-5-6-6	568	300	536 / 1829	2312	✓

Kerve is the curvaceous sibling of the Chube. As the name suggests the hanging bars have a gentle tactile bow. The design has an integral rear air vent for aesthetic appeal and ease of installation. Available in a wide range of heights and widths.

# Kerve

## Stainless Steel MD036

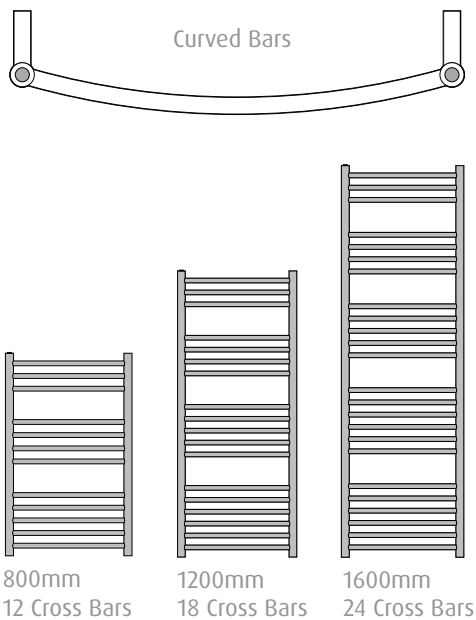

Polished stainless steel manufacture, suitable for all hot water systems. Please see page 158 for colour options.



For electric element & valve options see pages 152 & 156



### Kerve

Tube diameter	Dimensions (mm)			Bar Config	Pipe Centres	Electric element wattage	Output $\Delta T$ 50°C Watts/BTU's	Output $\Delta T$ 60°C BTU's	Stock or made to order
	H	W	D						
Ø 31.8 + 22mm									
MD036	800	500	120	3-4-5	468	125	243 / 829	1048	✓
MD036	800	600	130	3-4-5	568	150	269 / 918	1160	✓
MD036	1200	500	120	3-4-5-6	468	200	348 / 1187	1501	✓
MD036	1200	600	130	3-4-5-6	568	200	402 / 1372	1734	✓
MD036	1600	500	120	3-4-5-6-6	468	300	464 / 1583	2001	✓
MD036	1600	600	130	3-4-5-6-6	568	300	536 / 1829	2312	✓

# Galaxy

## Stainless Steel MD059

Galaxy has clean lines and plenty of hanging space. Manufactured from polished stainless steel. Please see page 158 for colour options. Suitable for all hot water systems.



1600mm  
7 cross bars

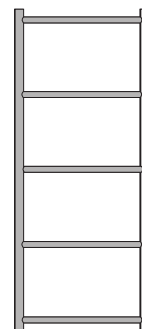

1200mm  
5 cross bars

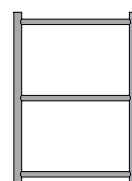

700mm  
3 cross bars



For electric element & valve options see pages 152 & 156



VL003

### Galaxy

Tube diameter	Dimensions (mm)			Bar Config	Pipe Centres	Electric element wattage	Output $\Delta T$ 50°C Watts/BTU's	Output $\Delta T$ 60°C BTU's	Stock or made to order
	H	W	D						
$\varnothing$ 31.8 + 22mm									
MD059	700	500	100	3	468	75	86 / 293	371	✓
MD059	1200	500	100	5	468	100	217 / 740	936	✓
MD059	1600	500	100	7	468	125	296 / 1010	1277	✓

High quality polished stainless steel. Pearl's chic styling and sensible design allows you to hang towels side by side. Suitable for all hot water systems. Please see page 158 for colour options.

# Pearl

## Stainless Steel MD058



600mm  
9 cross bars

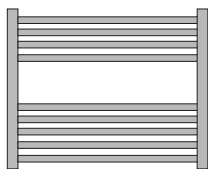

800mm  
12 cross bars

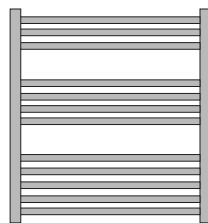

For electric element & valve options see pages 152 & 156



### Pearl

Tube diameter Ø 31.8 + 22mm	Dimensions (mm)			Bar Config	Pipe Centres	Electric element wattage	Output ΔT 50°C Watts/BTU's	Output ΔT 60°C BTU's	Stock or made to order
	H	W	D						
MD058	600	750	100	4-5	718	100	419 / 1430	1807	✓
MD058	600	1000	100	4-5	968	125	517 / 1764	2230	✓
MD058	800	750	100	3-4-5	718	125	529 / 1805	2281	✓
MD058	800	1000	100	3-4-5	968	150	682 / 2327	2941	✓

# Tune

## Wall Mounted MD003

Contemporary style, these multi-rails work well with most interior design schemes. Tune has straight cross rails and the Melody has a gentle curve. Both are exceptionally practical and work well in bathrooms and kitchens alike. Prices shown are chrome finished for central heating models.

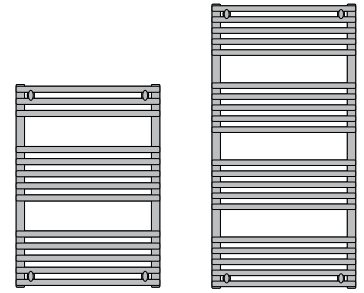

772mm  
13 Cross Bars

1186mm  
20 Cross Bars

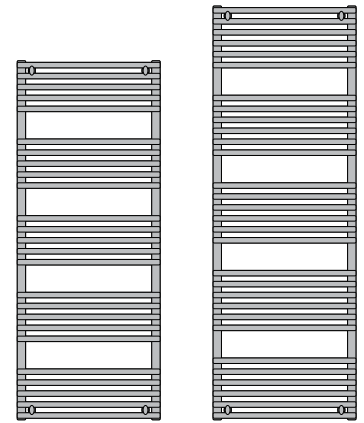

1508mm  
25 Cross Bars

1738mm  
30 Cross Bars

Optional Aroma Plug



Blanking Plug with Aroma Oil Dish  
AC035



For electric element & valve  
options see pages 152 & 156



### Tune (Straight)

Tube diameter Ø 32 + 22mm	Dimensions (mm)			Bar Config	Pipe Centres	Electric element wattage	Output ΔT 50°C Watts/BTU's	Output ΔT 60°C BTU's	Stock or made to order
	H	W	D						
MD003	772	500	80 - 95	3-5-5	450	125	290 / 989	1251	✓
MD003	772	600	80 - 95	3-5-5	550	200	347 / 1184	1497	✓
MD003	1186	500	80 - 95	5-5-5-5	450	300	465 / 1587	2005	✓
MD003	1186	600	80 - 95	5-5-5-5	550	300	553 / 1887	2385	✓
MD003	1508	500	80 - 95	5-5-5-5-5	450	400	581 / 1982	2506	✓
MD003	1508	600	80 - 95	5-5-5-5-5	550	400	686 / 2341	2959	✓
MD003	1738	500	80 - 95	6-6-6-6-6	450	600	687 / 2344	2963	✓
MD003	1738	600	80 - 95	6-6-6-6-6	550	600	815 / 2781	3515	✓



Our curved model of Tune - MD003, the MD004's tube on tube details produce a clean, modern and smooth look. Using the iconic form of the multirail alongside the extra detailed touches creates an alternative look for any setting.

# Melody

## Wall Mounted MD004



MS 15 C D E

### Melody (Curved)

Tube diameter Ø 32 + 22mm	Dimensions (mm)			Bar Config	Pipe Centres	Electric element wattage	Output ΔT 50°C Watts/BTU's	Output ΔT 60°C BTU's	Stock or made to order
	H	W	D						
MD004	772	500	100 - 115	3-5-5	450	125	290 / 989	1251	✓
MD004	772	600	100 - 115	3-5-5	550	200	347 / 1184	1497	✓
MD004	1186	500	100 - 115	5-5-5-5	450	300	465 / 1587	2005	✓
MD004	1186	600	100 - 115	5-5-5-5	550	300	553 / 1887	2385	✓
MD004	1508	500	100 - 115	5-5-5-5-5	450	400	581 / 1982	2506	✓
MD004	1508	600	100 - 115	5-5-5-5-5	550	400	686 / 2341	2959	✓
MD004	1738	500	100 - 115	6-6-6-6-6	450	600	686 / 2341	2959	✓
MD004	1738	600	100 - 115	6-6-6-6-6	550	600	815 / 2781	3515	✓

# Stella

Contemporary styling always makes an impact. Stella is manufactured from polished stainless steel. Suitable for all hot water systems.

## Stainless Steel MD034

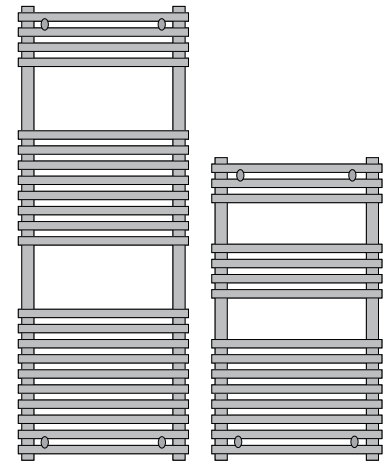

1200mm  
22 cross bars

800mm  
15 cross bars



For electric element & valve options see pages 152 & 156



### Stella

Tube diameter	Dimensions (mm)			Bar Config	Pipe Centres	Electric element wattage	Output $\Delta T$ 50°C Watts/BTU's	Output $\Delta T$ 60°C BTU's	Stock or made to order
	H	W	D						
$\varnothing$ 22 + 30mm									
MD034	800	450	75 - 95	3-4-8	400	125	412 / 1406	1777	✓
MD034	800	600	75 - 95	3-4-8	550	200	515 / 1757	2221	✓
MD034	1200	450	75 - 95	4-8-10	400	200	608 / 2074	2622	✓
MD034	1200	600	75 - 95	4-8-10	550	300	759 / 2590	3273	✓

Simple style, with bold straight cross rails and discreet fixed brackets. Manufactured from a high quality brass. Supplied with a hidden rear air vent for aesthetic appeal and ease of installation. Available in three different heights.

# Studio

## Wall Mounted MD006

If you need a different size, talk to us about our bespoke service. Prices shown are for all hot water and heating systems.

Please see pages 158 & 159 for finishes and colour options.



Rear air vent  
Capped off smooth ends for aesthetic appeal and ease of installation.

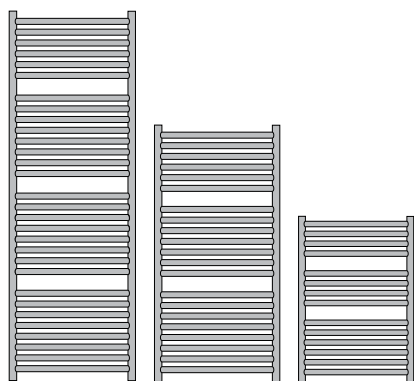

1435mm 30 Cross Bars  
1000mm 21 Cross Bars  
720mm 14 Cross Bars



Image showing Brushed Brass finish, same price as Chrome

The Studio model comes in a un-lacquered brushed brass finish as standard. An extra process for a lacquered finish can be provided for that premium look with a supplement charge of 20% on the price of chrome



For electric element & valve options see pages 152 & 156

VL003

### Studio

Tube diameter ∅ 31.8 + 25.4mm	Dimensions (mm)			Bar Config	Pipe Centres	Electric element wattage	Output ΔT 50°C Watts/BTU's	Output ΔT 60°C BTU's	Stock or made to order
	H	W	D						
MD006	720	500	90	4-4-6	468	125	327 / 1116	1410	✓
MD006	1000	500	90	6-7-8	468	200	482 / 1645	2079	✓
MD006	1435	500	90	6-8-8-8	468	300	690 / 2354	2976	✓



Images showing our Regency OC006  
See page 87



## Traditional

Go timeless and give your room a focal point that never fails to impress. Our range of classic designs, in a stunning choice of colours and finishes, add instant elegance to your room, each is handcrafted to stand the test of time.

# Regency

Floor and Wall Mounted LG004-MS

The classic column radiator towel rail, offering high heat output. Mild steel manufactured framework with an integral white mild steel column radiator. Colour option only applies to the inset radiator, not the frame.



Image showing Chrome frame with standard white radiator

Image showing Chrome frame with Bronze crackle radiator

Prices shown are chrome finished with a white integral radiator, central heating models.



For electric element & valve options see pages 152 & 156



## Regency MS

Tube diameter Ø 31.8mm	Dimensions (mm)			Sections	Face to Face connections	Electric element wattage	Output ΔT 50°C Watts/BTU's	Output ΔT 60°C BTU's	Stock or made to order
	H	W	D						
LG004-MS	963	538	230	5	393	200	392 / 1338	1691	✓
LG004-MS	963	673	230	8	528	300	554 / 1890	2389	✓
LG004-MS	963	763	230	10	618	400	653 / 2228	2816	✓

An authentic column radiator towel rail, offering high heat output. Brass manufactured framework with an integral white mild steel column radiator.

# Regency

Floor and Wall Mounted LG004-BR / OG006-BR



Prices shown are chrome finished for central heating models. Please see pages 158 & 159 for finishes and colour options.



For electric element & valve options see pages 152 & 156



## Regency BR

Tube diameter Ø 31.8mm	Dimensions (mm)			Sections	Face to Face connections	Electric element wattage	Output ΔT 50°C Watts/BTU's	Output ΔT 60°C BTU's	Stock or made to order
	H	W	D						
LG004C-BR	938	500	250	5	343	200	392 / 1338	1691	👤
LG004B-BR	938	675	250	8	518	400	554 / 1890	2389	👤
LG004A-BR	938	735	250	10	578	400	653 / 2228	2816	👤
OG006C-BR	938	500	250	5	343	200	392 / 1338	1691	👤
OG006B-BR	938	675	250	8	518	400	554 / 1890	2389	👤
OG006A-BR	938	735	250	10	578	400	653 / 2228	2816	👤

# Regency

Wall Mounted LG005 / OG015

A classic design with a compact height. This towel rail looks great alongside the bath, at the right height for reaching your luxuriously warm towel. Brass or Mild Steel manufactured framework with an integral white mild steel column radiator.

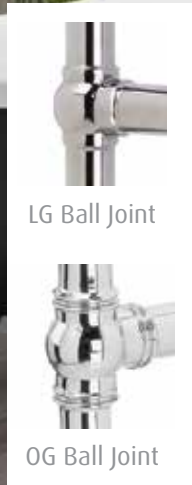

Other colours can be specified. Please see pages 158 & 159 for finishes and colour options. The colour option does not apply to the Mild Steel (MS) model inset radiators. Prices shown are chrome finished for central heating models.



For electric element & valve options see pages 152 & 156

MS 15 C D E

## Regency - MS

Tube diameter ∅ 31.8mm	Dimensions (mm)			Sections	Pipe Centres	Electric element wattage	Output ΔT 50°C Watts/BTU's	Output ΔT 60°C BTU's	Stock or made to order
	H	W	D						
LG005-MS	740	675	250	8	600	300	568 / 1938	2450	✓

BR 30 C D E

## Regency - BR

Tube diameter ∅ 31.8mm	Dimensions (mm)			Sections	Pipe Centres	Electric element wattage	Output ΔT 50°C Watts/BTU's	Output ΔT 60°C BTU's	Stock or made to order
	H	W	D						
LG005C-BR	740	500	250	5	425	200	384 / 1310	1656	👤
LG005B-BR	740	675	250	8	600	400	541 / 1846	2333	👤
LG005A-BR	740	735	250	10	660	400	643 / 2194	2773	👤
OG015-BR	740	500	250	5	425	200	384 / 1310	1656	👤
OG015-BR	740	675	250	8	600	400	541 / 1846	2333	👤
OG015-BR	740	735	250	10	660	400	643 / 2194	2773	👤



The Regency II Wall Mounted emanates traditional style. This handmade British design will stand the test of time. A Vogue UK registered design, liked for its heat output, hanging space and unique design.

# Regency II

## Wall Mounted LG036 / OG009



Brass manufactured framework with an integral white mild steel column radiator. Your choice of Legacy or Originals ball joint. Other radiator colours can be specified on ordering. Prices shown are chrome finished for central heating models. Please see pages 158 & 159 for finishes and colour options.



For electric element & valve options see pages 152 & 156  VL008

### Regency II

Tube diameter Ø 31.8mm	Dimensions (mm)			Sections	Pipe Centres	Electric element wattage	Output ΔT 50°C Watts/BTU's	Output ΔT 60°C BTU's	Stock or made to order
	H	W	D						
LG036-BR	825	500	150	5	425	200	384 / 1310	1656	
LG036-BR	825	675	150	8	600	400	570 / 1945	2458	
LG036-BR	825	735	150	10	660	400	671 / 2289	2894	
OG009C-BR	825	500	160	5	425	200	384 / 1310	1656	
OG009B-BR	825	675	160	8	600	400	570 / 1945	2458	
OG009A-BR	825	735	160	10	660	400	671 / 2289	2894	

# Regency Tall

Floor and Wall Mounted LG013-MS

Ideal for family bathrooms or a special en-suite. Mild steel manufactured framework with an integral white mild steel column radiator. Prices shown are chrome finished for central heating models.



LG013FW-MS

MS 15 C D E

For electric element & valve options see pages 152 & 156



## Regency Tall WM MS

Tube diameter Ø 31.8mm	Dimensions (mm)			Sections	Pipe Centres	Electric element wattage	Output ΔT 50°C Watts/BTU's	Output ΔT 60°C BTU's	Stock or made to order
	H	W	D						
LG013WM-MS	1403	575	250	5	500	400	824 / 2811	3554	✓

## Regency Tall FW MS

Tube diameter Ø 31.8mm	Dimensions (mm)			Sections	Face to Face connections	Electric element wattage	Output ΔT 50°C Watts/BTU's	Output ΔT 60°C BTU's	Stock or made to order
	H	W	D						
LG013FW-MS	1500	500	250	5	355	400	815 / 2781	3515	✓

The brass manufactured Regency Tall provides the luxury of a superior finish for the synonymous family bathroom of every year.

# Regency Tall

Floor and Wall Mounted LG013-BR / OG007-BR





Brass manufactured framework with an integral white mild steel column radiator. Available in optional metallic and colour finishes. Please see pages 158 & 159 for finishes and colour options. Prices shown are chrome finished for central heating models. Element position advised at point of ordering.



For electric element & valve options see pages 152 & 156



## Regency Tall BR

Tube diameter Ø 31.8mm	Dimensions (mm)			Sections	Face to Face connections	Electric element wattage	Output ΔT 50°C Watts/BTU's	Output ΔT 60°C BTU's	Stock or made to order
	H	W	D						
LG013FW-BR	1500	500	250	5	343	400	738 / 2518	3183	
OG007FW-BR	1500	500	250	5	343	400	738 / 2518	3183	

# Arcadia

## Floor Mounted LG017 / OG017

Arcadia, the classic war horse. A very British design which has stood the test of time. In brass or mild steel manufactured models, with plenty of towel hanging space.



LG Ball Joint

OG Ball Joint

Chromed to a mirror finish, other finishes are available, please see page 159.



For electric element & valve options see pages 152 & 156



### Arcadia - MS

Tube diameter Ø 31.8mm	Dimensions (mm)			Bar config	Face to Face connections	Electric element wattage	Output ΔT 50°C Watts/BTU's	Output ΔT 60°C BTU's	Stock or made to order
	H	W	D						
LG017-MS	850	598	233	7	453	2 x 100	439 / 1498	1893	✓



### Arcadia - BR

Tube diameter Ø 31.8mm	Dimensions (mm)			Bar config	Face to Face connections	Electric element wattage	Output ΔT 50°C Watts/BTU's	Output ΔT 60°C BTU's	Stock or made to order
	H	W	D						
LG017-BR	850	600	235	7	443	2 x 100	439 / 1498	1893	✘
OG017-BR	850	600	275	7	443	2 x 100	439 / 1498	1893	✘

Inspired by yesteryear. The Baroque uses a classical white mild steel column radiator within a handcrafted, chrome plated, brass framework. Superior heat output and towel hanging space are abundant in this imposing feature design.

# Baroque

## Floor Mounted LG014 / OG016



Please see pages 158 & 159 for finishes and colour options. Prices shown are chrome finished for central heating models.



For electric element & valve options see pages 152 & 156



### Baroque

Tube diameter Ø 31.8mm	Dimensions (mm)			Sections	Face to Face connections	Electric element wattage	Output ΔT 50°C Watts/BTU's	Output ΔT 60°C BTU's	Stock or made to order
	H	W	D						
LG014-BR	900	675	325	8	518	200 + 300	871 / 2972	3756	👉
OG016-BR	900	675	350	8	518	200 + 300	871 / 2972	3756	👉

# Ballerina

Floor and Wall Mounted LG024A-MS / LG021-MS

This Ballerina wall and floor mounted towel rail offered in a mild steel Legacy ball joint version as detailed on this page.



Prices shown are chrome finished central heating models. The high quality brass versions (opposite) are available with Legacy or Originals Balljoint. The LG021-MS comes with added balljoints on the inlet connections to complement the style further.

MS 15 C D E

For electric element & valve options see pages 152 & 156



## Ballerina MS

Tube diameter Ø 31.8mm	Dimensions (mm)			Bar config	Face to Face connections	Electric element wattage	Output ΔT 50°C Watts/BTU's	Output ΔT 60°C BTU's	Stock or made to order
	H	W	D						
LG024A-MS	848	598	138	4	454	100	163 / 556	703	✓
LG021-MS	1549	598	138	5	454	150	310 / 1058	1337	✓

High quality brass, supremely durable for longevity. The Ballerina wall and floor is available with your choice of Legacy or Originals ball joint.

# Ballerina

## Floor and Wall Mounted LG021 / LG024 / OG003



LG Ball Joint



OG Ball Joint



LG021H  
5 Bars



LG021E  
4 Bars



LG024A  
3 Bars

6 bar models are available to order as bespoke

Prices shown are chrome finished for all heating and hot water systems. Other finishes are available, please see page 159.



For electric element & valve options see pages 152 & 156

VL018

### Ballerina BR

Tube diameter Ø 31.8mm	Dimensions (mm)			Bar config	Face to Face connections	Electric element wattage	Output ΔT 50°C Watts/BTU's	Output ΔT 60°C BTU's	Stock or made to order
	H	W	D						
LG024C-BR	938	575	138	3	418	100	163 / 556	703	👉
LG024A-BR	938	675	138	3	518	125	195 / 665	841	👉
LG024B-BR	938	825	138	3	668	150	207 / 706	893	👉
LG021A-BR	1238	525	138	4	368	125	239 / 815	1031	👉
LG021E-BR	1238	675	138	4	518	150	266 / 908	1147	👉
LG021D-BR	1538	525	138	5	368	150	292 / 996	1259	👉
LG021H-BR	1538	675	138	5	518	150	327 / 1116	1410	👉
OG003A-BR	938	575	138	3	418	100	163 / 556	703	👉
OG003B-BR	938	675	138	3	518	125	195 / 665	841	👉
OG003C-BR	938	825	138	3	668	150	207 / 706	893	👉
OG003D-BR	1238	525	138	4	368	125	239 / 815	1031	👉
OG003E-BR	1238	675	138	4	518	150	266 / 908	1147	👉
OG003F-BR	1538	525	138	5	368	125	292 / 996	1259	👉
OG003G-BR	1538	675	138	5	518	150	327 / 1116	1410	👉

# Ballerina

The Ballerina wall mounted towel rail is offered in a Legacy ball joint mild steel version, as detailed on this page.

## Wall Mounted LG010A-MS



Prices shown are chrome finished central heating models.

The high quality brass versions (opposite) are available with Legacy or Originals Balljoint.



For electric element & valve options see pages 152 & 156



VL008

### Ballerina MS

Tube diameter	Dimensions (mm)			Bar config	Pipe Centres	Electric element wattage	Output $\Delta T$ 50°C Watts/BTU's	Output $\Delta T$ 60°C BTU's	Stock or made to order
	H	W	D						
$\varnothing$ 31.8mm									
LG010A-MS	748	498	124	4	424	100	169 / 577	729	✓



High quality brass, durable for longevity, the Ballerina is available with your choice of Legacy (as pictured) or Originals ball joint.

# Ballerina

Wall Mounted LG025 / LG010 / LG021 / OG002



LG Ball Joint



OG Ball Joint



LG021C  
5 Bars



LG021B  
4 Bars



LG025A  
3 Bars

6 bar models are available to order as bespoke

Prices shown are chrome finished for all heating and hot water systems. Other finishes are available, please see page 159.



VL018

For electric element & valve options see pages 152 & 156



## Ballerina BR

Tube diameter Ø 31.8mm	Dimensions (mm)			Bar config	Pipe Centres	Electric element wattage	Output ΔT 50°C Watts/BTU's	Output ΔT 60°C BTU's	Stock or made to order
	H	W	D						
LG025A-BR	675	675	125	3	600	100	167 / 570	720	👉
LG025B-BR	675	825	125	3	750	125	190 / 648	819	👉
LG010A-BR	750	500	125	4	425	100	169 / 577	729	👉
LG021B-BR	1275	525	125	4	450	125	239 / 815	1031	👉
LG021F-BR	1275	675	125	4	600	150	266 / 908	1147	👉
LG021C-BR	1575	525	125	5	450	125	292 / 996	1259	👉
LG021G-BR	1575	675	125	5	600	150	327 / 1116	1410	👉
OG002B-BR	675	675	135	3	600	100	167 / 570	720	👉
OG002C-BR	675	825	135	3	750	125	190 / 648	819	👉
OG002D-BR	750	525	135	4	450	100	169 / 577	729	👉
OG002A-BR	1275	525	135	4	450	125	239 / 815	1047	👉
OG002E-BR	1275	675	135	4	600	150	266 / 908	1151	👉
OG002F-BR	1575	525	135	5	450	125	292 / 996	1259	👉
OG002G-BR	1575	675	135	5	600	150	327 / 1116	1410	👉

# Grandeur

## Floor and Wall Mounted GD032FW

Reflecting the quality and craftsmanship of a bygone age. Manufactured from our most robust 38mm diameter brass tube, this towel rail is of a timeless nature and would sit well in any traditional setting.



Image showing Antique Copper finish



Grandeur Ball Joint

Available in two heights to suit your requirements. Brass manufactured with a chrome finish as standard. Other finishes are available, please see page 159.



For electric element & valve options see pages 152 & 156



### Grandeur

Tube diameter Ø 38.1mm	Dimensions (mm)			Bar config	Face to Face connections	Electric element wattage	Output ΔT 50°C Watts/BTU's	Output ΔT 60°C BTU's	Stock or made to order
	H	W	D						
GD032FW	943	686	163	3	522	125	243 / 829	1048	👇
GD032FW	1243	686	163	4	522	200	319 / 1088	1376	👇

The wall mounted Grandeur provides ample warm towel hanging space. With classic looks and robust traditional quality, this towel rail is made to outlive fashion. Brass manufactured with a chrome finish as standard.

# Grandeur

## Wall Mounted GD032WM

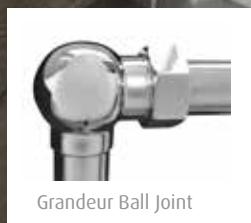

Grandeur Ball Joint

Bespoke finishes are available at an additional cost, please see page 159 for other finishes.



For electric element & valve options see pages 152 & 156



VL008

### Grandeur

Tube diameter Ø 38.1mm	Dimensions (mm)			Bar config	Pipe Centres	Electric element wattage	Output ΔT 50°C Watts/BTU's	Output ΔT 60°C BTU's	Stock or made to order
	H	W	D						
GD032WM	686	686	154	3	600	100	220 / 751	949	👉
GD032WM	1286	636	154	4	550	150	321 / 1095	1384	👉

# Butler

Floor and Wall Mounted LG035 / OG004

This traditional design is tactile and sturdy, a centrepiece for a classically designed bathroom. Brass manufactured, shown with the Originals ball joint. Chrome finish as standard.



Bespoke finishes are available at an additional cost, please see page 159 for other finishes.



For electric element & valve options see pages 152 & 156



VL008

## Butler

Tube diameter Ø 31.8mm	Dimensions (mm)			Bar config	Face to Face connections	Electric element wattage	Output ΔT 50°C Watts/BTU's	Output ΔT 60°C BTU's	Stock or made to order
	H	W	D						
LG035	940	75	488	4	268	100	156 / 532	673	👇
OG004	965	75	488	4	268	100	156 / 532	673	👇

Small is always beautiful. The Hamlet is perfect for en suites and downstairs WCs where space is at a premium, but warm dry towels are still welcomed.

# Hamlet

Wall Mounted LG037 / OG001



Image showing Antique Bronze finish

Brass manufactured with a chrome finish as standard with Originals or Legacy ball joints. Bespoke finishes are available at an additional cost, please see page 159 for other finishes.



LG Ball Joint



OG Ball Joint



VL008

For electric element & valve options see pages 152 & 156



## Hamlet

Tube diameter Ø 31.8mm	Dimensions (mm)			Bar config	Pipe Centres	Electric element wattage	Output ΔT 50°C Watts/BTU's	Output ΔT 60°C BTU's	Stock or made to order
	H	W	D						
LG037	235	575	125	2	500	50	79 / 270	341	
OG001	235	575	135	2	500	50	79 / 270	341	

# Elizabeth

Floor and Wall Mounted LG003 / OG019

With sculptured lines and quality ball joints the Elizabeth has a twist on tradition. Brass or Mild Steel manufactured models Chrome finished as standard.



LG Ball Joint

OG Ball Joint

Bespoke finishes are available at an additional cost, please see page 159 for other finishes.



For electric element & valve options see pages 152 & 156



VL008

## Elizabeth - MS

Tube diameter Ø 31.8 + 25 + 19mm	Dimensions (mm)			Bar config	Face to Face connections	Electric element wattage	Output ΔT 50°C Watts/BTU's	Output ΔT 60°C BTU's	Stock or made to order
	H	W	D						
LG003-MS	963	673	168	8	528	125	290 / 989	1251	✓



## Elizabeth - BR

Tube diameter Ø 31.8 + 25.4mm	Dimensions (mm)			Bar config	Face to Face connections	Electric element wattage	Output ΔT 50°C Watts/BTU's	Output ΔT 60°C BTU's	Stock or made to order
	H	W	D						
LG003A	938	675	138	7	518	150	290 / 989	1251	👉
LG003B	938	825	138	7	668	150	372 / 1269	1604	👉
OG019A	938	675	138	7	518	150	290 / 989	1251	👉
OG019B	938	825	138	7	668	150	372 / 1269	1604	👉

The wall mounted Elizabeth is available in two widths with your choice of Legacy (as this page) or Originals ball joints. Chrome finished as standard.

# Elizabeth

Wall Mounted LG003 / OG019



LG Ball Joint



OG Ball Joint

Bespoke finishes are available at an additional cost, please see page 159 for other finishes.



For electric element & valve options see pages 152 & 156



VL008

## Elizabeth BR

Tube diameter ∅ 31.8 + 25.4mm	Dimensions (mm)			Bar config	Pipe Centres	Electric element wattage	Output ΔT 50°C Watts/BTU's	Output ΔT 60°C BTU's	Stock or made to order
	H	W	D						
LG003D	740	675	125	7	600	125	290 / 989	1251	👉
LG003E	740	825	125	7	750	150	372 / 1269	1604	👉
OG019D	740	675	135	7	600	125	290 / 989	1251	👉
OG019E	740	825	135	7	750	150	372 / 1269	1604	👉

Sales: +44 (0) 1902 387000 | 103

# Art Moderne

## Floor and Wall Mounted OG011

Deco decadence in a nutshell. High quality hexagonal brass tube manufacture, crafted to a gleaming finish. Available in two sizes and chrome finish as standard.



Art Moderne  
Corner Joint

Bespoke finishes are available at an additional cost, please see page 159 for other finishes.



For electric element & valve options see pages 152 & 156



VL008

### Art Moderne

Tube diameter Ø 32mm HEX	Dimensions (mm)			Bar config	Face to Face connections	Electric element wattage	Output ΔT 50°C Watts/BTU's	Output ΔT 60°C BTU's	Stock or made to order
	H	W	D						
OG011B	943	600	175	3	428	100	197 / 672	850	👇
OG011A	1543	550	168	5	378	125	318 / 1085	1371	👇



Perfect for any bathroom with Deco sanitary and brassware, this ever popular style never fades. The wall mounted Art Moderne is available in three different sizes to suit your room. Brass manufactured with a chrome finish as standard.

# Art Moderne

Wall Mounted OG010



Art Moderne  
Corner Joint

Bespoke finishes are available at an additional cost, please see page 159 for other finishes.



For electric element & valve options see pages 152 & 156



VL006

## Art Moderne

Tube diameter Ø 32mm HEX	Dimensions (mm)			Bar config	Pipe Centres	Electric element wattage	Output ΔT 50°C Watts/BTU's	Output ΔT 60°C BTU's	Stock or made to order
	H	W	D						
OG010A	836	550	145	4	450	100	211 / 720	910	👉
OG010B	836	700	145	4	600	125	247 / 843	1065	👉
OG010C	986	700	145	4	600	125	263 / 897	1134	👉

Sales: +44 (0) 1902 387000 | 105

# Art Moderne II

## Wall Mounted OG021

Quality hexagonal brass tube meets a practical brass multirail for an elegant look. Chrome finished as standard. Bespoke finishes are available at an additional cost, please see page 159 for other finishes.



Unique Art Moderne joint with hexagonal upright and round horizontals



For electric element & valve options see pages 152 & 156



VL008

### Art Moderne II

Tube diameter Ø 32 HEX + 25.4mm	Dimensions (mm)			Bar config	Pipe Centres	Electric element wattage	Output ΔT 50°C Watts/BTU's	Output ΔT 60°C BTU's	Stock or made to order
	H	W	D						
OG021	700	532	83 - 106	7-7	500	125	354 / 1208	1527	👇
OG021	1000	482	83 - 106	6-6-6	450	150	429 / 1464	1850	👇
OG021	1200	482	83 - 106	5-5-5-5	450	200	487 / 1662	2100	👇

This characterful robustly British towel warmer hails quality and craftsmanship. Made for you with your choice of the Legacy or Originals ball joint (pictured). Brass manufactured with a chrome finish as standard.

# Penthouse

## Wall Mounted LG018 / OG020

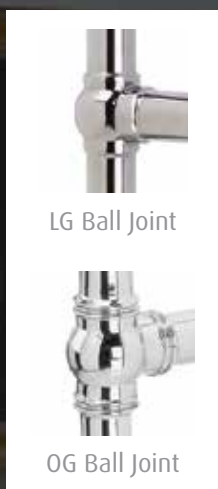



Bespoke finishes are available at an additional cost, please see page 159 for other finishes.



For electric element & valve options see pages 152 & 156  VL018

### Penthouse

Tube diameter Ø 31.8 + 25.4mm	Dimensions (mm)			Bar config	Pipe Centres	Electric element wattage	Output ΔT 50°C Watts/BTU's	Output ΔT 60°C BTU's	Stock or made to order
	H	W	D						
LG018	1100	550	100	20	500	200	532 / 1815	2294	
OG020	1100	550	100	18	500	200	493 / 1682	2126	

Sales: +44 (0) 1902 387000 | 107

# Colonnade IV

## Wall Mounted LG023

The distinguished design features both rope and reed tubing providing a stand-out product. Manufactured from high quality brass with a chrome finish as standard. Bespoke finishes are available at an additional cost.



Featuring both rope and reed tubing



Rope



Reed

Image showing Antique Copper finish



For electric element & valve options see pages 152 & 156



### Colonnade IV

Tube diameter Ø 25.4mm	Dimensions (mm)			Bar config	Pipe Centres	Electric element wattage	Output ΔT 50°C Watts/BTU's	Output ΔT 60°C BTU's	Stock or made to order
	H	W	D						
LG023A	775	475	125	4	400	100	169 / 577	729	👇
LG023B	775	575	125	4	500	100	190 / 648	819	👇

This chrome finished brass tubed simple design with Legacy ball joints would sit happily in either a traditional or more contemporary setting. Bespoke finishes are available at an additional cost, please see page 159 for other finishes.

# Vintage

## Wall Mounted LG010B



Prices shown are for chrome finished models.



For electric element & valve options see pages 152 & 156



### Vintage

Tube diameter Ø 31.8mm	Dimensions (mm)			Bar config	Pipe Centres	Electric element wattage	Output ΔT 50°C Watts/BTU's	Output ΔT 60°C BTU's	Stock or made to order
	H	W	D						
LG010B	750	475	105	4	400	100	169 / 577	729	✓

Sales: +44 (0) 1902 387000 | 109

# Nexus Grand III

## Wall Mounted TM003

When combinations are right, something good happens. This towel rail has a great heat output from a twin column radiator inset. It is skillfully combined in a brass framework and chrome plated.



The two column radiator inset comes in white as standard, other colours can be specified at an additional cost. Please see pages 158 & 159 for finishes and colour options. Prices shown are chrome finished for central heating models.



For electric element & valve options see pages 152 & 156



### Nexus Grand III

Tube diameter	Dimensions (mm)			Sections	Pipe Centres	Electric element wattage	Output $\Delta T$ 50°C Watts/BTU's	Output $\Delta T$ 60°C BTU's	Stock or made to order
	H	W	D						
$\varnothing$ 25.4 + 15mm	900	525	142 - 160	8	500	400	726 / 2477	3131	
TM003									

This single curved bar version is a more modern take on the traditional. With the same great heat output and high quality manufacture. The mild steel two column radiator inset comes in white as standard, other colours can be specified at an additional cost.

# Nexus Grand IV

Wall Mounted TM004



Quality brass manufactured framework. Please see pages 158 & 159 for finishes and colour options. Prices shown are chrome finished for central heating models.



For electric element & valve options see pages 152 & 156



## Nexus Grand IV

Tube diameter ∅ 25.4 + 22mm	Dimensions (mm)			Sections	Pipe Centres	Electric element wattage	Output ΔT 50°C Watts/BTU's	Output ΔT 60°C BTU's	Stock or made to order
	H	W	D						
TM004	900	590	214 - 232	8	500	400	699 / 2385	3015	

Sales: +44 (0) 1902 387000 | 111

# Sequel III

## Wall Mounted TM005

The Sequel III is manufactured from high quality brass, with a three column mild steel inset radiator, which comes in white as standard, other colours can be specified at an additional cost. Curved hanging bars give a modern edge to this traditional style.



Please see pages 158 & 159 for finishes and colour options. Prices shown are chrome finished for central heating models.



For electric element & valve options see pages 152 & 156



VL006

### Sequel III

Tube diameter ∅ 25.4 + 15mm	Dimensions (mm)			Sections	Pipe Centres	Electric element wattage	Output ΔT 50°C Watts/BTU's	Output ΔT 60°C BTU's	Stock or made to order
	H	W	D						
TM005	1000	550	182-200	5	475	400	741 / 2528	3196	



The Sequel V has Legacy ball joints and emits a fine traditional sense of style. With brass manufactured framework and a white three column mild steel integral radiator it produces a high heat output. Other radiator colours can be specified.

# Sequel V

## Wall Mounted TM006



Prices shown are chrome finished for central heating models. Please see pages 158 & 159 for finishes and colour options.



For electric element & valve options see pages 152 & 156



VL018

### Sequel V

Tube diameter Ø 25.4mm	Dimensions (mm)			Sections	Pipe Centres	Electric element wattage	Output ΔT 50°C Watts/BTU's	Output ΔT 60°C BTU's	Stock or made to order
	H	W	D						
TM006	1000	525	191-209	5	475	400	716 / 2443	3088	

Sales: +44 (0) 1902 387000 | 113

# Basin Stands

Floor and Wall Mounted





Kensington BSS004  
As pictured with nickel finish (left)



Mayfair BSS003  
To suit rounded basins



Chelsea BSS006  
Pictured heated and wall mounted



City BSS007  
Wall mounted with Art Linea joints

### Heated or Unheated Basin Stands

Vogue have developed a range of handcrafted brass basin stands produced to order. The styles illustrated can be altered to suit your exact requirements with your choice of metallic finish. Other finishes are available, please see page 159.

Please contact us for further information and a specific quotation.

Richmond BSS001

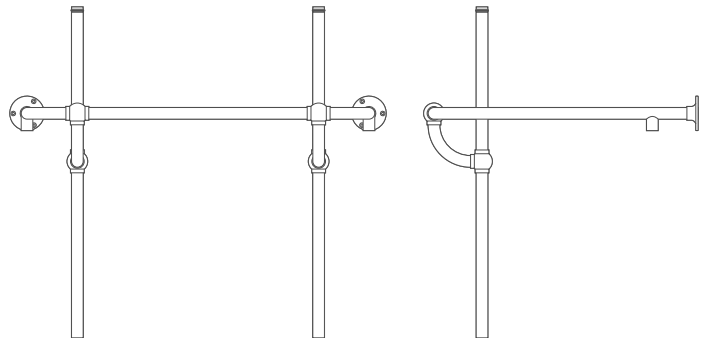

Linea Richmond BSS002

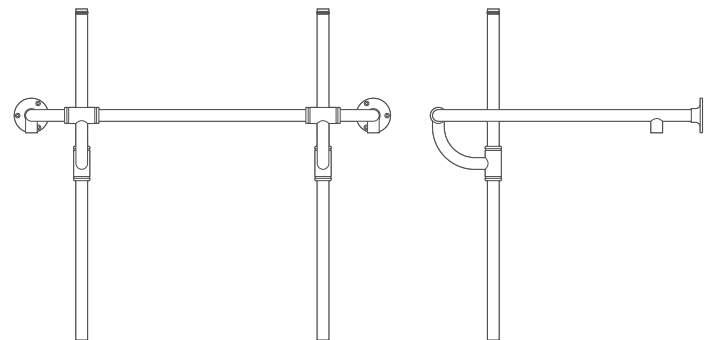

Belgravia BSS005

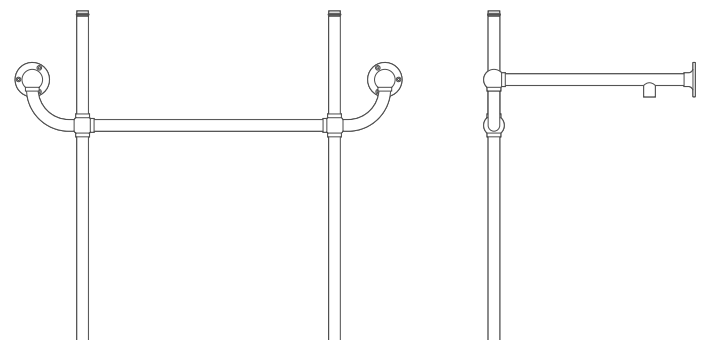

# Shower Curtain Rails

## Wall Mounted

Complement Your Bathroom...

Our handmade range of shower curtain rails are beautifully engineered from high quality brass tubing for longevity. As standard they are finished in chrome. Please talk to us if you require other metal finishes or non standard sizes. Other finishes are available, please see page 159.

Oval Ceiling Mounted SCR 1

Ø 25.4mm

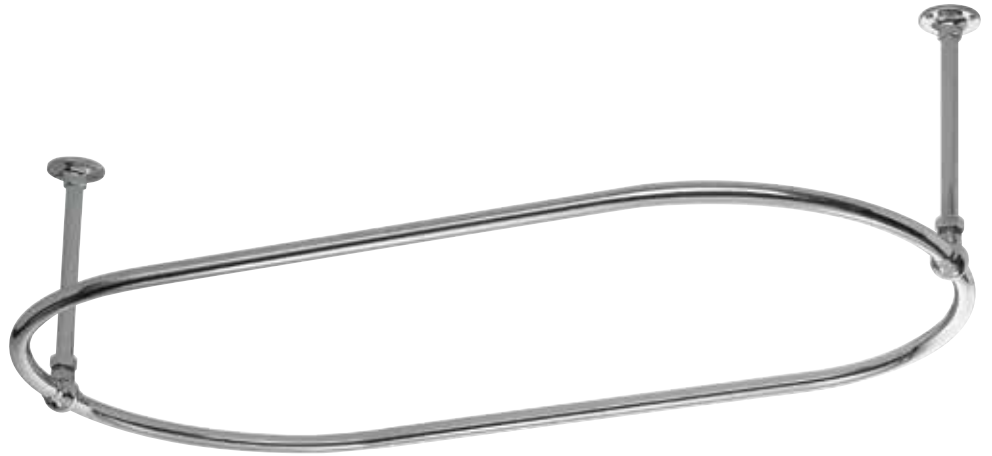

Single Ended Oval Wall and Ceiling Mounted SCR 2

Ø 25.4mm

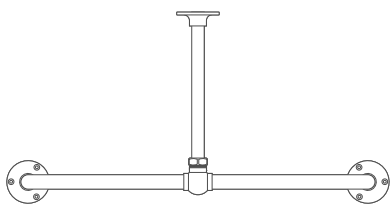
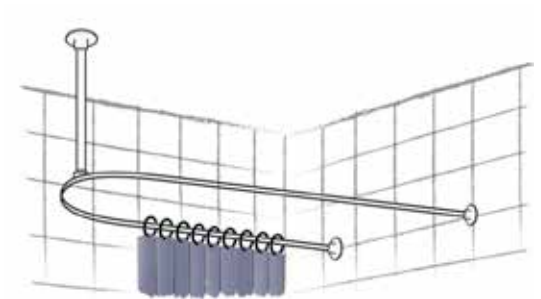
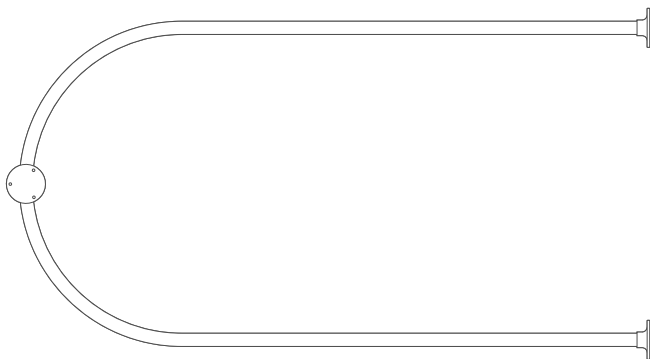

Straight Wall Mounted SCR 3

Ø 31.8mm

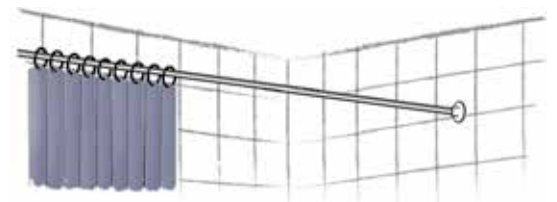

Curved Corner Wall Mounted SCR 4  
 Ø 25.4mm

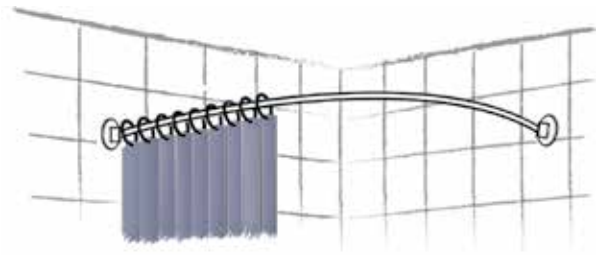
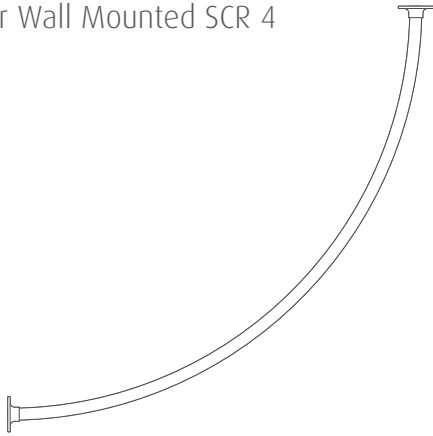

Circular wall Mounted SCR 5  
 Ø 25.4mm



Right Angle Wall Mounted SCR 6  
 Ø 25.4mm

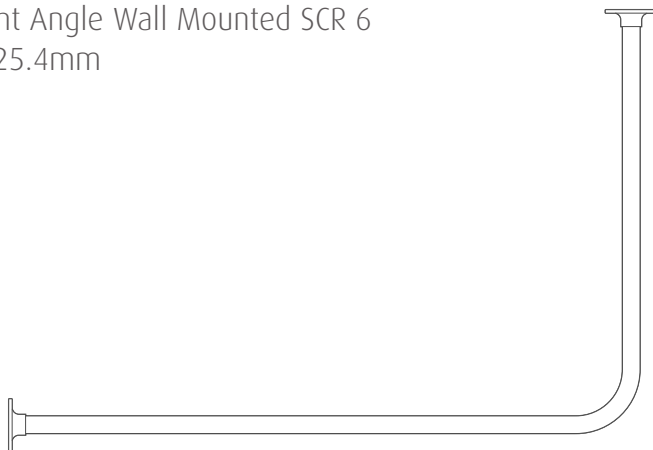

## Shower Curtain Rail

	Dimensions (mm)			Description	Stock or made to order
	H	W	D		
SCR 1.1	325	1275	625	Oval shape mounted to ceiling	Hand icon
SCR 1.2	325	1625	625	Oval shape mounted to ceiling	Hand icon
SCR 2.1	338	1238	675	Single ended oval shape mounted to wall and ceiling	Hand icon
SCR 2.2	338	1538	675	Single ended oval shape mounted to wall and ceiling	Hand icon
SCR 3.1	75	1700	75	Straight wall mounted bar	Hand icon
SCR 3.2	75	2000	75	Straight wall mounted bar	Hand icon
SCR 4.1	75	938	938	Round curve for corner applications	Hand icon
SCR 4.2	75	1238	1238	Round curve for corner applications	Hand icon
SCR 5.1	75	775dia	827	Circular wall mounted	Hand icon
SCR 5.2	75	925dia	977	Circular wall mounted	Hand icon
SCR 6.1	75	938	638	Right angled curve for corner applications	Hand icon
SCR 6.2	75	1238	638	Right angled curve for corner applications	Hand icon
SCR 6.3	75	1538	638	Right angled curve for corner applications	Hand icon



Images showing our Serenade DR008 in Black  
See page 125

## Designer Radiators

Looking for a real statement piece?

Our exclusive designer radiators are constantly leading the trend in interior design. Created by some of the UK's most celebrated interior designers, they are guaranteed to turn heads.



# Suave

## Wall Mounted MD056

The Suave has a strong, minimalist design, ideal for more contemporary properties. Manufactured in high quality mild steel and finished in anthracite or white. Please see page 158 for colour options.



For electric element & valve options see pages 152 & 156



### Suave

	Dimensions (mm)			Pipe Centres	Electric element wattage	Output $\Delta T$ 50°C Watts/BTU's	Output $\Delta T$ 60°C BTU's	Stock or made to order
	H	W	D					
MD056	1800	500	85-100	450	600	669 / 2283	2885	✓



The Zest is a bold contemporary radiator. Manufactured in high quality mild steel and finished in anthracite or white. Please see page 158 for colour options.

# Zest

## Wall Mounted MD076

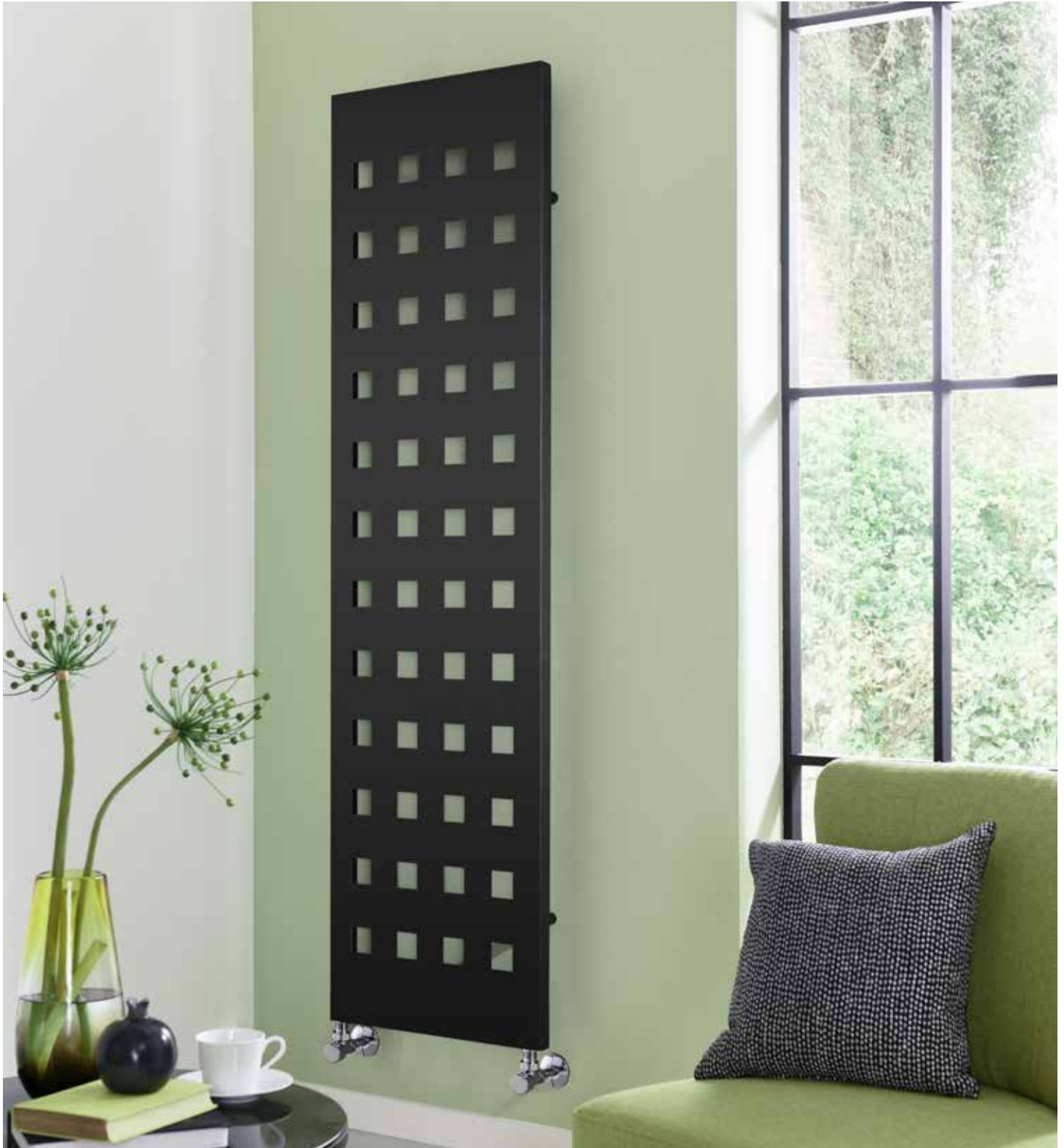

- MS
- 15
- C
- D
- E
- 

For electric element & valve options see pages 152 & 156



### Zest

	Dimensions (mm)			Pipe Centres	Electric element wattage	Output $\Delta T$ 50°C Watts/BTU's	Output $\Delta T$ 60°C BTU's	Stock or made to order
	H	W	D					
MD076	1800	500	85-100	451	600	667 / 2276	2877	✓

Sales: +44 (0) 1902 387000 | 121

# Kate

A contemporary radiator with cylindrical uprights available in white. Manufactured from mild steel, suitable for closed heating systems and with a 15 year Warranty.

## Wall Mounted DR019

Optional Accessory



Towel Bar - Chrome or White  
AC041 (375mm wide)

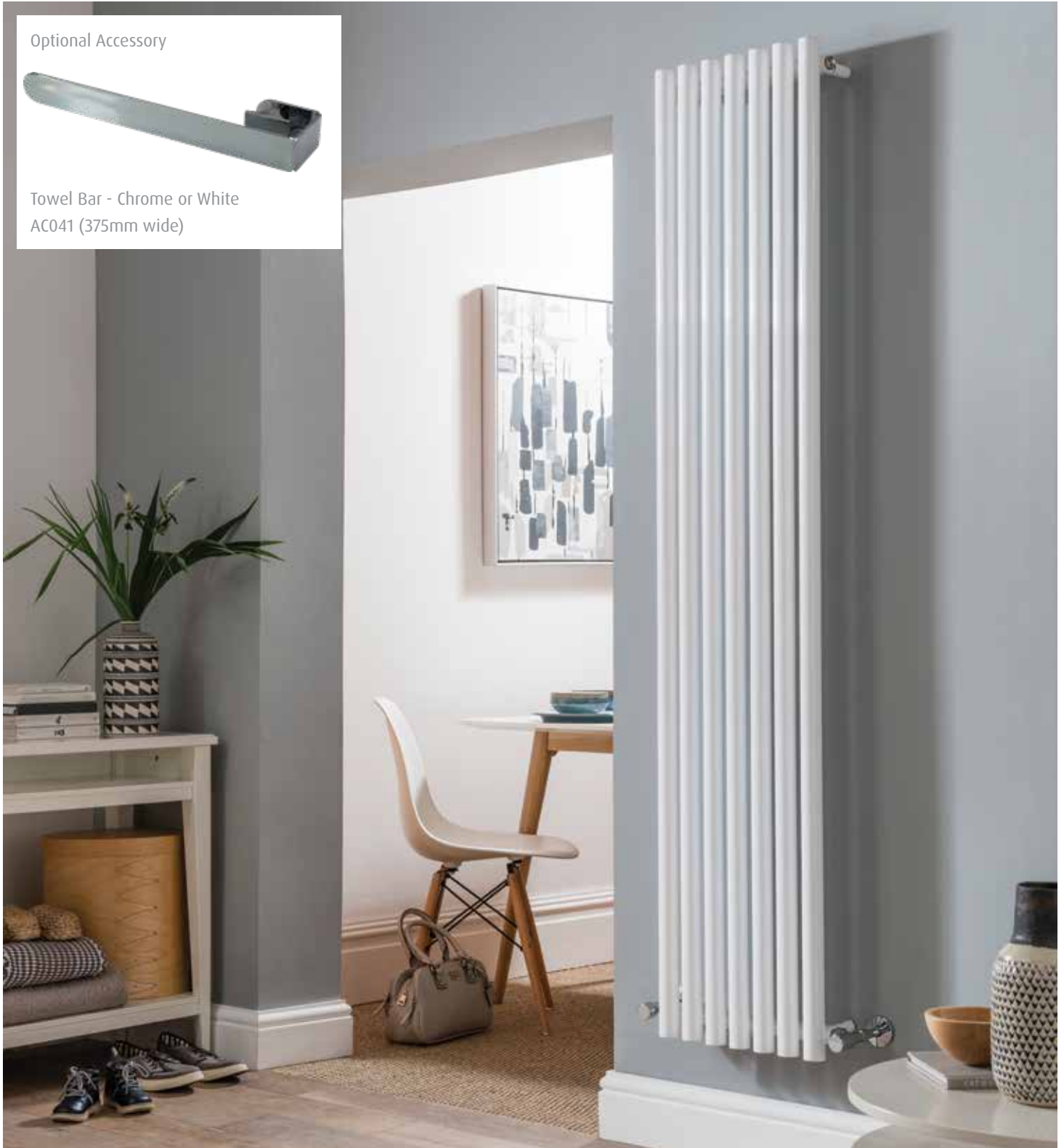

For valve options see page 156

VL003

### Kate

Tube diameter Ø 32 + 38mm	Dimensions (mm)			End to End connections	Output ΔT 50°C Watts/BTU's	Output ΔT 60°C BTU's	Stock or made to order
	H	W	D				
DR019	1800	370	134	370	700 / 2388	3019	✓

A bold and clean lined tubular radiator. The Ordinate will integrate well into any room of the house and available in four heights. The picture illustrates the tallest model. Available as single or double versions.

# Ordinate

## Wall Mounted MD005



### Optional Accessories



Towel Bar - Chrome

AC023B (305mm wide)

AC023C (395mm wide)



Frosted Robe Hook  
AC031



Image showing double version in Anthracite

Optional towel bars and robe hooks are available to give the Ordinate supreme function for bathrooms and kitchens.

MS 15 C

For electric element & valve options see pages 152 & 156



VL003

### Ordinate Colours

Tube diameter Ø 22 + 32mm	Dimensions (mm)			Bar config	End to End connections	Output ΔT 50°C Watts/ BTU's	Output ΔT 60°C BTU's	Stock or made to order
	H	W	D					
MD005	1800	525	113-128	12	525	676 / 2307	2915	✓
MD005	1800	595	113-128	13	595	734 / 2504	3166	✓
MD005DP Double	1800	525	99	12-12	525	914 / 3119	3942	✓
MD005DP Double	1800	595	99	13-13	595	992 / 3146	3976	✓

Sales: +44 (0) 1902 387000 | 123

# Vision

## Wall Mounted DR022

A full length mirror built into a stylish tubular radiator makes Vision an asset in every room in your home. Manufactured from high quality mild steel and available in a Chrome, White or Anthracite finish to blend with any décor.



MS 15 C

For valve options see page 156



### Vision

Tube diameter	Dimensions (mm)			End to End connections	Output ΔT 50°C Watts/BTU's		Output ΔT 60°C BTU's		Stock or made to order
	H	W	D		Chrome	A & W	Chrome	A & W	
Ø 32 + 25mm									
DR022	1800	600	104	600	473 / 1614	713 / 2433	2040	3075	✓

Serenade is a vertical contemporary design radiator, manufactured from high quality mild steel with finish options of chrome, textured matt black & white. Please see page 158 for colour options.

# Serenade

## Wall Mounted DR008



Optional Accessory

Towel Bar - White, Chrome or Black  
 AC039A (266mm wide)  
 AC039B (375mm wide)



For valve options see page 156  VL014

### Serenade

Tube diameter		Dimensions (mm)			Bar config	End to End connections	Output $\Delta T$ 50°C Watts/BTU's		Output $\Delta T$ 60°C BTU's		Stock or made to order
$\varnothing$ 30mm	40 x 10mm	H	W	D			chrome	painting	chrome	painting	
DR008		1200	252	70	5	252	242 / 826	367 / 1252	1044	1583	✓
DR008		1200	358	70	7	358	339 / 1157	515 / 1757	1462	2221	✓
DR008		1800	252	70	5	252	351 / 1198	533 / 1819	1514	2299	✓
DR008		1800	358	70	7	358	491 / 1675	746 / 2545	2118	3217	✓

Sales: +44 (0) 1902 387000 | 125

# Fly Line Vertical

## Wall Mounted DR003

Fly Line is a strong, minimalist design ideal for contemporary properties. These radiators come with a choice of single or double panel versions with the double panel offering an increased heat output.



Optional Accessory for single panel Vertical Fly Line

Towel Bar - Stainless Steel  
AC032 - 450mm wide



Showing double panel design Fly Line Vertical in white

Fly Line Vertical and Horizontal are available in a variety of size options and come as standard in white or anthracite. Please see page 158 for colour options, available on single panel versions only.



For valve options see page 156



### Fly Line Vertical

Tube diameter 38mm 70 x 11mm	Dimensions (mm)			No. of sections	End to End connections	Output $\Delta T$ 50°C Watts/BTU's	Output $\Delta T$ 60°C BTU's	Stock or made to order
	H	W	D					
DR003 (single panel)	1800	224	71	3	224	402 / 1372	1734	✓
DR003 (single panel)	1800	376	71	5	376	670 / 2286	2890	✓
DR003 (single panel)	1800	528	71	7	528	938 / 3200	4045	✓
DR003 (single panel)	1800	680	71	9	680	1206 / 4115	5201	✓
DR003DP (double panel)	1800	224	71	3	224	627 / 2139	2704	✓
DR003DP (double panel)	1800	376	71	5	376	1045 / 3566	4507	✓
DR003DP (double panel)	1800	528	71	7	528	1463 / 4992	6310	✓
DR003DP (double panel)	1800	680	71	9	680	1881 / 6418	8112	✓

# Fly Line Horizontal

Wall Mounted DR004



For valve options see page 156

VL003



## Fly Line Horizontal

Tube diameter  38mm  70 x 11mm	Dimensions (mm)			No. of sections	Pipe centres	Output ΔT 50°C Watts/BTU's	Output ΔT 60°C BTU's	Stock or made to order
	H	W	D					
DR004 (single panel)	452	900	63	6	850	420 / 1433	1811	✓
DR004 (single panel)	452	1200	63	6	1150	552 / 1883	2381	✓
DR004 (single panel)	604	900	63	8	850	560 / 1911	2415	✓
DR004 (single panel)	604	1200	63	8	1150	736 / 2511	3174	✓
DR004DP (double panel)	452	900	112	6	850	654 / 2231	2821	✓
DR004DP (double panel)	452	1200	112	6	1150	858 / 2927	3700	✓
DR004DP (double panel)	604	900	112	8	850	872 / 2975	3761	✓
DR004DP (double panel)	604	1200	112	8	1150	1144 / 3903	4934	✓

Sales: +44 (0) 1902 387000 | 127

# Lure Single

## Wall Mounted DR020

A statement piece that oozes sophistication and practical good looks, with a bank of closely fitting oval tubes to provide aesthetic appeal and efficient heat output. Available in chrome or white. Please see page 158 for colour options.

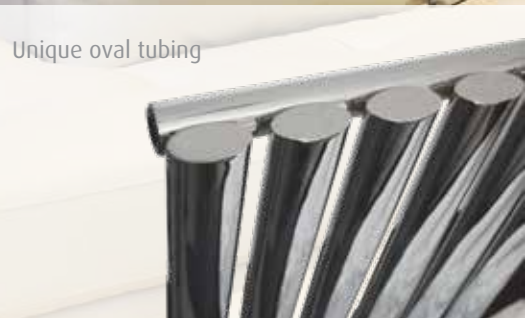

Unique oval tubing



For valve options see page 156

VL003

### Lure Single

Tube diameter		Dimensions (mm)			Bar config	End to End connections	Output $\Delta T$ 50°C Watts/BTU's		Output $\Delta T$ 60°C BTU's		Stock or made to order
$\varnothing$		H	W	D			chrome	white	chrome	white	
32mm	25 x 50mm oval	1800	352	83	6	352	505 / 1723	722 / 2463	2178	3114	✓



A modern designer radiator with twin rows of oval tubes for elegance and high output available in white or anthracite. Manufactured from mild steel, suitable for closed heating systems and with a 15 year Warranty.

# Lure Double

## Wall Mounted DR020DP



For valve options see page 156

VL003



### Lure Double

Tube diameter		Dimensions (mm)			Bar config	End to End connections	Output ΔT 50°C Watts/BTU's White or Anthracite	Output ΔT 60°C BTU's White or Anthracite	Stock or made to order
∅	□	H	W	D					
32mm	25 x 50mm oval	1800	352	105-110	6	352	1014 / 3460	4373	✓

Sales: +44 (0) 1902 387000 | 129

# Astute Horizontal

## Aluminium Wall Mounted DR036

Provides great efficiency, easy to install with its lightweight material and has low water content, enabling a quick heat up time. Available in white or anthracite.



AL 30 H



For valve options see page 156

VL003

### Astute Horizontal

	Dimensions (mm)			Sections	End to End connections	Output $\Delta T$ 50°C Watts/BTU's	Output $\Delta T$ 60°C BTU's	Stock or made to order
	H	W	D					
DR036 (single panel)	600	565	76.5	6	565	506/1726	2182	✓
DR036 (single panel)	600	755	76.5	8	755	674/2300	2907	✓
DR036 (single panel)	600	945	76.5	10	945	842/2873	3631	✓
DR036 (single panel)	600	1135	76.5	12	1135	1011/3450	4360	✓
DR036 (single panel)	600	1325	76.5	14	1325	1147/3914	4947	✓
DR036 (single panel)	600	1515	76.5	16	1515	1342/4579	5788	✓
DR036DP (double panel)	600	560	117.5	6	560	841 / 2869	3627	✓
DR036DP (double panel)	600	748	117.5	8	748	1121 / 3825	4835	✓
DR036DP (double panel)	600	936	117.5	10	936	1401 / 4780	6042	✓
DR036DP (double panel)	600	1124	117.5	12	1124	1654 / 5643	7133	✓
DR036DP (double panel)	600	1312	117.5	14	1312	1908 / 6510	8229	✓

Compact aluminium radiator to fit the smallest of space while providing the benefits of low water content and quick heat up. Available in textured black, anthracite and white.

# Astute Compact

## Aluminium Wall Mounted DR034



Textured Black

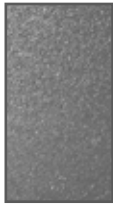

Textured Anthracite



Smooth White

### Optional Accessory



Towel Bar -  
Chrome, Textured Black,  
Textured Anthracite or  
Textured White

AC064 (230mm wide)



Close up of top view

New for 2021

\*Elements can only be fitted in the tapping provided at the bottom right hand side of the radiator.



For valve options see page 156

VL003

AL 30 H E D

### Astute Compact

DR034	Dimensions (mm)			Sections	End to End connections	Electric element wattage	Output $\Delta T$ 50°C Watts/BTU's	Output $\Delta T$ 60°C s BTU's	Stock or made to order
	H	W	D						
DR034	1800	185	90	2	185	300	436 / 1488	1880	✓

Sales: +44 (0) 1902 387000 | 131

# Astute Vertical Single

## Aluminium Wall Mounted DR035

Provides great efficiency, easy to install with its lightweight material. Has a low water content so has a quick heat up time. Available in white or anthracite.



### Optional Accessory



Towel Bar - Chrome

AC066 (320mm wide)

AC066 (415mm wide)

AC066 (510mm wide)



VL003

AL

30

H

For valve options see page 156

## Astute Vertical Single

	Dimensions (mm)			Sections	End to End connections	Output ΔT 50°C Watts/BTU's	Output ΔT 60°C BTU's	Stock or made to order
	H	W	D					
DR035	1800	280	76.5	3	280	843/ 2876	3636	✓
DR035	1800	375	76.5	4	375	1124/ 3835	4848	✓
DR035	1800	470	76.5	5	470	1405/ 4794	6059	✓

Designed for the home, providing great efficiency. Has a low water content, enabling a quick heat up time. Available in white or anthracite.

# Astute Vertical Double

Aluminium Wall Mounted DR035DP



Optional Accessory



Towel Bar - Chrome

AC066DP (320mm wide)

AC066DP (415mm wide)

AC066DP (510mm wide)

AL 30 H

For valve options see page 156  VL003

## Astute Vertical Double

	Dimensions (mm)			Sections	End to End connections	Output $\Delta T$ 50°C Watts/BTU's	Output $\Delta T$ 60°C BTU's	Stock or made to order
	H	W	D					
DR035DP	1800	278	117.5	3	278	1441/ 4917	6215	✓
DR035DP	1800	372	117.5	4	372	1916/ 6537	8263	✓
DR035DP	1800	466	117.5	5	466	2348/ 8011	10126	✓

Sales: +44 (0) 1902 387000 | 133

# Mode II

## Wall or Floor Mounted CN027

Contemporary styling with sleek rounded tubes. Mode II has all the attributes of a great column radiator with edgy attitude. These wall hung radiators will complement many areas of the home. Available in white RAL 9016 and Metallic Anthracite as standard. Please see page 158 for colour options.

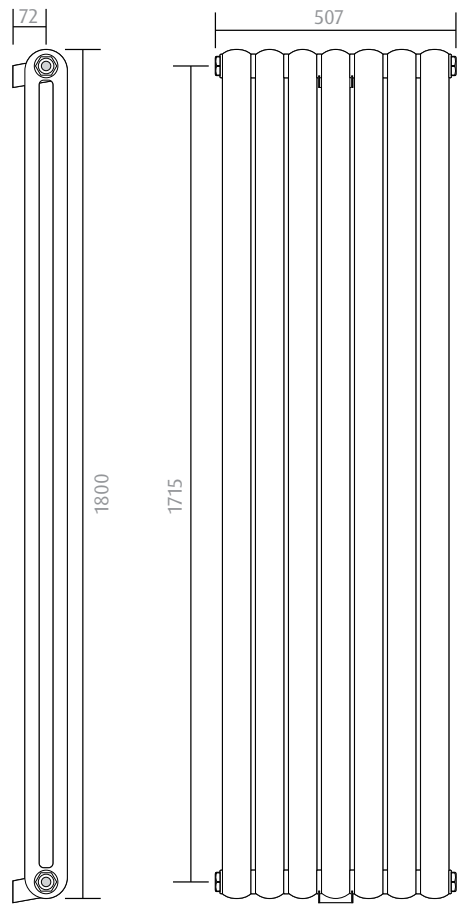

### Optional Accessories

Towel Bar - White, Chrome or Anthracite  
 AC034A (60 x 200mm wide)  
 AC034B (60 x 340mm wide)  
 AC034C (60 x 480mm wide)



Feet - White or Anthracite  
 AC038



Metallic Anthracite option  
 (non-textured)

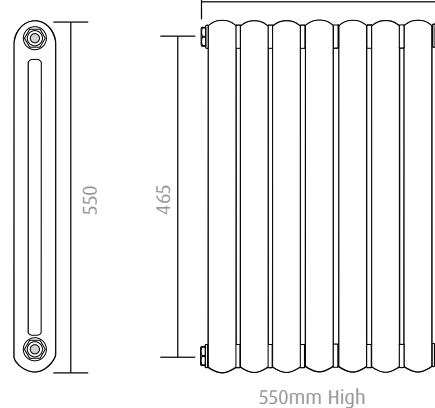
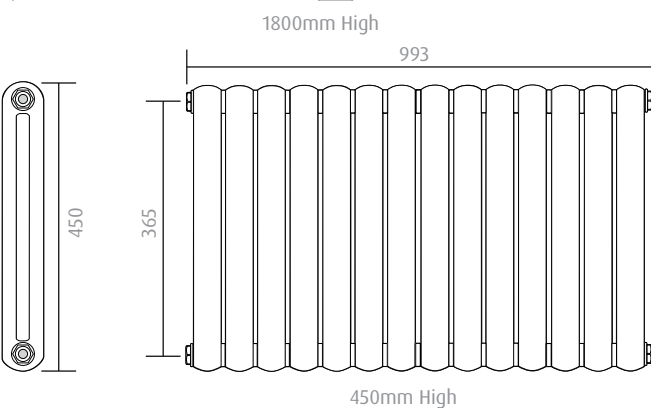

For valve options see page 156

VL004

VL003



## Mode II

	Dimensions (mm)			Number of Sections	Output ΔT 50°C Watts/BTU's	Output ΔT 60°C BTU's	Stock or made to order
	H	W	D				
CN027	450	507	90	7	398 / 1358	1716	✓
CN027	450	785	90	11	625 / 2133	2695	✓
CN027	450	993	90	14	796 / 2716	3433	✓
CN027	450	1202	90	17	966 / 3296	4166	✓
CN027	550	507	90	7	505 / 1723	2178	✓
CN027	550	785	90	11	793 / 2706	3420	✓
CN027	550	993	90	14	1009 / 3443	4352	✓
CN027	550	1202	90	17	1226 / 4183	5287	✓
CN027	1800	229	90	3	922 / 3146	3976	✓
CN027	1800	370	90	5	1538 / 5248	6633	✓
CN027	1800	507	90	7	2153 / 7346	9285	✓



# Mode

## Wall or Floor Mounted



Mode suits traditional properties, yet also looks great in contemporary settings.

Available in a wide range of sizes, so you can choose a radiator which exactly suits your space and required heat output. The standard colour finish is white RAL 9016. Other RAL colours are available. Please see page 150 for other colour options. Subject to manufacturing tolerances.

Please note, contemporary colours available on 2, 3 & 4 column only.

Wall brackets are included, feet and other fixing accessories are detailed on the next pages. For valve options see page 156

### Standard Stock Sizes (opposite)

We stock 2, 3 and 4 column radiators. Heights range from 300mm great for under window sills, to a 1800mm tall version. There are many sizes in between.

### Non Standard Sizes (next pages)

Non standard sizes include 5 and 6 columns ranging from 300mm - 2000mm high and detailed on the next pages. Non stocked and colour finish options have an eight week lead time.



VL004 Arne Thermostatic option



VL008

For valve options see page 156



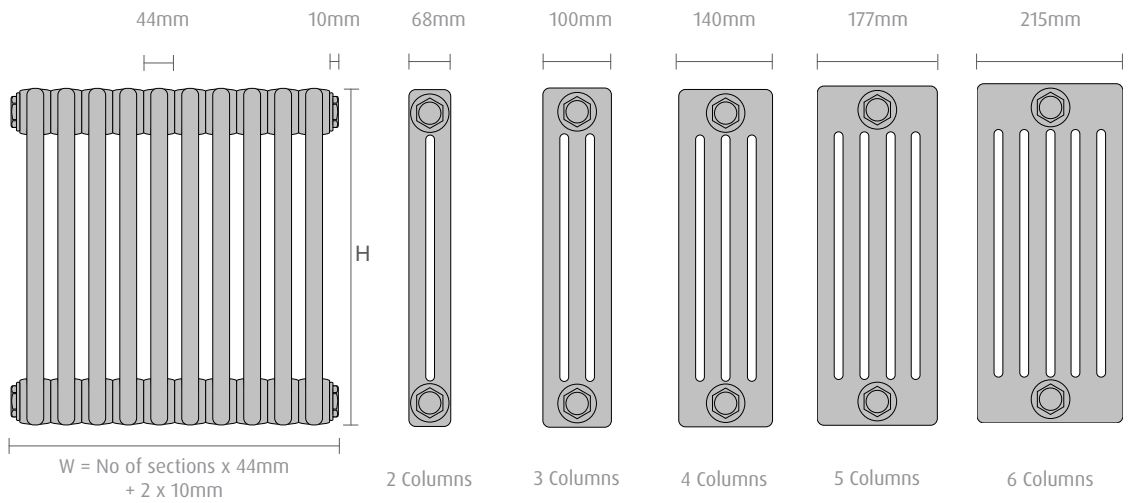

## Mode

	Dimensions (mm)			Number of Sections	Output $\Delta T$ 50°C Watts/BTU's	Output $\Delta T$ 60°C BTU's	Stock or made to order
	H	W	D				
<b>2 Column Radiators</b>							
2C-050-10	500	460	68	10	371 / 1266	1600	✓
2C-050-18	500	812	68	18	688 / 2347	2967	✓
2C-050-22	500	988	68	22	817 / 2788	3524	✓
2C-060-10	600	460	68	10	440 / 1501	1898	✓
2C-060-14	600	636	68	14	616 / 2102	2657	✓
2C-060-18	600	812	68	18	792 / 2702	3416	✓
2C-060-22	600	988	68	22	968 / 3303	4175	✓
2C-060-24	600	1076	68	24	1056 / 3603	4554	✓
2C-060-28	600	1252	68	28	1232 / 4204	5313	✓
2C-180-6	1800	284	68	6	774 / 2641	3338	✓
2C-180-8	1800	372	68	8	1032 / 3521	4451	✓
2C-180-10	1800	460	68	10	1290 / 4401	5563	✓
2C-180-12	1800	548	68	12	1548 / 5282	6676	✓
<b>3 Column Radiators</b>							
3C-050-14	500	636	100	14	720 / 2457	3105	✓
3C-050-18	500	812	100	18	926 / 3160	3994	✓
3C-050-22	500	988	100	22	1131 / 3859	4878	✓
3C-050-24	500	1076	100	24	1234 / 4210	5322	✓
3C-050-28	500	1252	100	28	1440 / 4913	6210	✓
3C-060-10	600	460	100	10	609 / 2078	2626	✓
3C-060-14	600	636	100	14	852 / 2907	3674	✓
3C-060-18	600	812	100	18	1097 / 3743	4731	✓
3C-060-20	600	900	100	20	1218 / 4156	5253	✓
3C-060-24	600	1076	100	24	1462 / 4988	6305	✓
3C-060-30	600	1340	100	30	1827 / 6234	7879	✓
3C-075-10	750	460	100	10	750 / 2559	3235	✓
3C-075-14	750	636	100	14	1050 / 3583	4528	✓
3C-075-18	750	812	100	18	1350 / 4606	5822	✓
3C-075-22	750	988	100	22	1650 / 5630	7116	✓
3C-075-26	750	1164	100	26	1950 / 6653	8410	✓
3C-180-8	1800	372	100	8	1412 / 4818	6090	✓
3C-180-10	1800	460	100	10	1764 / 6019	7608	✓
3C-180-12	1800	548	100	12	2117 / 7223	9130	✓
<b>4 Column Radiators</b>							
4C-030-20	300	900	140	20	850 / 2900	3666	✓
4C-030-30	300	1340	140	30	1275 / 4350	5499	✓
4C-060-14	600	636	140	14	1147 / 3914	4947	✓
4C-060-18	600	812	140	18	1475 / 5033	6361	✓
4C-060-20	600	900	140	20	1638 / 5589	7064	✓
4C-060-24	600	1076	140	24	1966 / 6708	8479	✓
4C-075-14	750	636	140	14	1417 / 4835	6111	✓
4C-075-18	750	812	140	18	1822 / 6217	7858	✓
4C-075-22	750	988	140	22	2227 / 7599	9605	✓
4C-075-26	750	1164	140	26	2632 / 8980	11351	✓

# Mode

## Bespoke



This service gives the opportunity to order non standard sizes. Choose from wall or floor standing. These radiators are supplied in white RAL 9016. Coloured finishes are available, please see page 158 for colour options. Please note, contemporary colours available on 2, 3 & 4 column only. The lead time for delivery is approximately eight weeks. The sections cannot be joined on site. We only supply complete radiators, practical considerations need to be given to weight, carriage, handling and accessibility. Where necessary large radiators can be supplied in module format. Contact our sales office for further information.



VL003 For valve options see page 156

### Accessories for Mode Column Radiators

Stock or made to order

### Calculations for Sizing a Radiator



Column Radiator Feet AC028



Adjustable Feet AC024  
Height from 90mm to 120mm.  
Must only be used with top retaining stay.



Base Plate Cover AC025  
For use with adjustable feet (above).



Top Retaining Stay AC026  
For use with adjustable feet.



Standing Brackets  
For use with glass walls etc...



Welded Feet  
(Increase height by 100mm)  
Up to 20 sections requires two feet  
21 to 40 sections three feet  
41 to 58 sections four feet

Required output is 1200 watts

Space available is 1000 mm high x 750 mm wide. Approx radiator dimensions 900mm high x 600mm wide.  
(Taking into account space for valves)

Number of sections possible

Width (600mm) divide by 45mm per section + allowance for each side.  
 $600 - 24$  divided by  $46 = 12$  sections.

Heat output per section

Divide your required output by sections.  
 $1200$  watts divided by  $12 = 100$  watts per section.

Selecting your radiator section

$4-750 @ 102$  watts per section. Therefore  
 $12$  sections @  $102$  per section =  $1224$  watts @  $50$  degrees C delta T.

Price calculation

$12 \times 43.00 = 516.00$  ex VAT,  
Plus feet if floor standing and any other non standard support brackets you may require.

Dimensions

The nominal overall length of a radiator = number of section x  $46$ mm -  $24$ mm for reducing bushes (12mm each end).  
Subject to manufacturing tolerance of +/- 0.7mm (1.5%) per section.



Mode Sections	Dimensions (mm)		Output $\Delta T$ 50°C Watts/BTU's	Output $\Delta T$ 60°C BTU's	Stock or made to order
	H	D			
<b>2 Column Section</b>					
2-300	300	66	24 / 82	104	
2-400	400	66	31 / 106	134	
2-500	500	66	37 / 126	160	
2-600	600	66	44 / 150	190	
2-750	750	66	55 / 188	238	
2-900	900	66	65 / 222	282	
2-1000	1000	66	72 / 246	312	
2-1200	1200	66	86 / 293	372	
2-1500	1500	66	108 / 369	468	
2-1800	1800	66	129 / 440	558	
2-2000	2000	66	144 / 491	623	
<b>3 Column Section</b>					
3-300	300	107	33 / 113	143	
3-400	400	107	42 / 143	181	
3-500	500	107	52 / 177	224	
3-600	600	107	61 / 208	264	
3-750	750	107	75 / 256	325	
3-900	900	107	90 / 307	389	
3-1000	1000	107	99 / 338	429	
3-1200	1200	107	118 / 403	511	
3-1500	1500	107	147 / 502	637	
3-1800	1800	107	177 / 604	766	
3-2000	2000	107	197 / 672	852	
<b>4 Column Section</b>					
4-300	300	148	43 / 147	186	
4-400	400	148	56 / 191	242	
4-500	500	148	69 / 235	298	
4-600	600	148	82 / 280	355	
4-750	750	148	102 / 348	441	
4-900	900	148	121 / 413	524	
4-1000	1000	148	134 / 457	579	
4-1200	1200	148	159 / 543	689	
4-1500	1500	148	197 / 672	852	
4-1800	1800	148	235 / 802	1017	
4-2000	2000	148	260 / 887	1125	
<b>5 Column Section</b>					
5-300	300	189	52 / 177	224	
5-400	400	189	68 / 232	294	
5-500	500	189	83 / 283	359	
5-600	600	189	98 / 334	424	
5-750	750	189	121 / 413	524	
5-900	900	189	143 / 488	619	
5-1000	1000	189	158 / 539	683	
5-1200	1200	189	188 / 641	813	
5-1500	1500	189	232 / 792	1004	
5-1800	1800	189	277 / 945	1198	
5-2000	2000	189	307 / 1048	1329	
<b>6 Column Section</b>					
6-300	300	230	63 / 215	273	
6-400	400	230	82 / 280	355	
6-500	500	230	101 / 345	437	
6-600	600	230	120 / 409	519	
6-750	750	230	148 / 505	640	
6-900	900	230	175 / 597	757	
6-1000	1000	230	193 / 659	836	
6-1200	1200	230	229 / 781	990	
6-1500	1500	230	282 / 962	1220	
6-1800	1800	230	334 / 1140	1446	
6-2000	2000	230	369 / 1259	1596	





## Electric

Designed to work in places where it's just not practical for your central heating system to go, our electric range is a stylish solution for any space. Plus they have all our hallmark design and quality craftsmanship.

# Comfort

## Wall Mounted EL028

Comfort is ideal for compact situations. It is electric only and is manufactured in high quality mild steel, chromed to a mirror finish. Electrical components are covered by our two year warranty. Has a rating of IP55.



Detail shot to show angled bars

MS 15 E

### Comfort

EL028	Dimensions (mm)			Power wattage	Stock or made to order
	H	W	D		
EL028	675	545	95	120	✓

Uncomplicated and chic. The linear styling of Simplicity adds a sense of sophistication to any room. Slimline and discreet it provides the comfort of warm fluffy towels or bathrobes. This is electric drylined only.

# Simplicity II

## Wall Mounted EL040 / EL045



Delivered complete, no cover shroud necessary.

Manufactured in high quality stainless steel. Electrical components are covered by our two year warranty. IP44 when installed as per installation instructions.

SS 2 E

### Simplicity II

	Dimensions (mm)	Description	Power W	Stock or made to order
	H			
EL040 Round	1100	Round tube 30mm Ø	28-30	✓
EL040 Round	1500	Round tube 30mm Ø	42-44	✓
EL040 Round	1800	Round tube 30mm Ø	52-55	✓
EL045 Cube	1100	Square tube 30 x 30mm	33-35	✓
EL045 Cube	1500	Square tube 30 x 30mm	49-52	✓
EL045 Cube	1800	Square tube 30 x 30mm	64-68	✓

# Envirovent

## SILENT Design 100

- Silent elastic blocks
- Sealed for life ball bearings
- Back draught shutter and airflow guide vanes
- High performance and quality
- Incredibly silent running
- Energy efficient
- 8 Watts / 230 Volts
- IP45 rated



A range of 100mm domestic axial extract fans for wall or ceiling installations, designed to solve ventilation problems in WC's and bathrooms. Fitted with motors mounted on silent elastic blocks, the fans deliver incredibly silent running and exceptional performance and stylish design.

## ECO dMEV

- Up to 6 adjustable trickle speed settings
- Timer, humidity sensor and pull cord models
- Complies with Building Regulations. Part F for system 3 Continuous Mechanical Extract
- SAP Appendix Q eligible achieving a low specific fan power of 0.28 W/l/s
- Incredibly silent running - Below 20 dB(A)
- One fan for all situations, both walls and ceilings
- Low Energy DC 1.5 Watts - Low voltage version available
- 4 Interchangeable front panel trims



The ECO dMEV has been designed and developed to offer the market a constant volume, continuously running, decentralised extract fan for the lowest power consumption, the lowest noise and lowest lifecycle costs.

## SILENT MV

- Sound absorbent insulation
- Incredibly silent running
- 360° rotating connection box
- Sealed for life ball bearings
- Fitted with a two speed motor
- Complies with building regulations
- High performance with flexible location
- Easy installation and maintenance
- IP44 rated



The SILENT MV fan range offers one of the most versatile fan systems on the market today. Due to its flexibility it can be used in a multitude of small and medium fan installations. Especially advantageous in applications where the system may be running for long periods throughout the day, the acoustic benefits of the SILENT MV fans ensure that optimum comfort is achieved without the disturbance of noisy ventilation systems.

## SILENT 100

- Also available in silver on silent elastic blocks
- Sealed for life ball bearings
- Back draught shutter and airflow guide vanes
- High performance and quality
- Incredibly silent running
- Significant energy savings
- 8 Watts / 230 Volts or 13 Watts / 12 Volts options
- IP45 / IP57 SELV version



100mm domestic axial extract fans for wall or ceiling installations. Designed to solve ventilation problems in WC's and bathrooms. Fitted to motors mounted on silent elastic blocks, fans are incredibly silent running and exceptional performance.

## Optional Kits



ENV-WALL KIT



ENV-CEILING KIT



ENV-SOFIT KIT



ENV-3M FLEX



ENV-6M FLEX



Fan	Description	Airflow rates l/s (m <sup>3</sup> /h)	Stock or made to order
<b>Silent Design 100</b>			
SILDES100 S	White Standard Model	22 (85)	✓
SILDES100 SS	Silver Standard Model	22 (85)	✓
SILDES100 T	White Timer Model	22 (85)	✓
SILDES100 TS	Silver Timer Model	22 (85)	✓
SILDES100 HT	White Adjustable Humidity Sensor Model	22 (85)	✓
SILDES100 HTS	Silver Adjustable Humidity Sensor Model	22 (85)	✓
<b>Eco dMEV</b>			
Eco dMEV S	Standard Model	18 (65)	✓
Eco dMEV T	Adjustable Run-On Timer Model	18 (65)	✘
Eco dMEV HT	Adjustable Humidity Sensor and Timer Model	18 (65)	✘
Eco dMEV HTP	Pull Cord Adjustable Humidity Sensor and Timer Model	18 (65)	✘
Eco dMEV S SELV	Standard (SELV) Model	18 (65)	✘
Eco dMEV T SELV	Adjustable (SELV) Run-On Timer Model	18 (65)	✘
Eco dMEV HT SELV	Adjustable (SELV) Humidity Sensor and Timer Model	18 (65)	✓
Eco dMEV HTP SELV	Pull Cord Adjustable (SELV) Humidity Sensor and Timer Model	18 (65)	✓
<b>Silent MV</b>			
SILMV 160100 S	Silent 2 speed in line fan	50 (80)	✓
SILMV 160100 T	Silent single speed inline fan with adjustable timer	50 (80)	✓
SILMV 250100 S	Silent 2 speed in line fan	50 (80)	✘
SILMV 250100 T	Silent single speed inline fan with adjustable timer	50 (80)	✘
<b>Silent 100</b>			
Silent-100 S	Standard Model	26 (95)	✓
Silent-100 T	Adjustable Timer Model	26 (95)	✓
Silent-100 HT	Adjustable Humidity Sensor Model	26 (95)	✓
Silent-100 PIR	PIR Model	26 (95)	✘
Silent-100 SS SILVER	Silver Standard Model	26 (95)	✓
Silent-100 ST SILVER	Silver Adjustable Timer Model	26 (95)	✓
<b>Optional Kits</b>			
ENV-WALL KIT	Wall Grill and pipe		✓
ENV-CEILING KIT	Ceiling Vent, 6M Flex and 2 flex ties		✓
ENV-SOFIT KIT	Wall grill, 3M Flex and 2 flex ties		✓
ENV-3M FLEX	3 metre flex 100 dia		✓
ENV-6M FLEX	6 metre flex 100 dia		✓

# Electric Underfloor Heating

There is nothing that quite matches the comfort of warm feet when getting out of the bath or shower, especially in the cold winter months! Imagine stepping onto warm tiles controlled to the temperature you prefer.

Electric underfloor heating works by gently warming the mass of floor which in turn warms the rest of the room. Our underfloor heating kit is quick and easy to install. Ideally timed when you are fitting a new kitchen or bathroom. Electrical components are covered by a two year warranty.

## The Underfloor Heating Kit Includes

- The correct size heating mat.
- Digital touch screen timer and thermostat.
- Floor sensor and floor sensor mounting pipe.
- Multimeter to check installation at every stage.
- Comprehensive installation manual and control card.



## Putting You in Control...

The digital touch screen, completely programmable timer and thermostatic controller enables you to fully regulate the temperature and control when the heating is on or off. The manual override means at the touch of a button the temperature can be higher or lower to suit as and when it is needed.

E

2 Warranty on the control

30 Warranty on the mat

## EUFH

	Area Metre(s)	Rated Power Wattage per mat	Stock or made to order
EUFH150-01.0	1.0	150	✓
EUFH150-01.5	1.5	225	✓
EUFH150-02.0	2.0	300	✓
EUFH150-02.5	2.5	375	✓
EUFH150-03.0	3.0	450	✓
EUFH150-03.5	3.5	525	✓
EUFH150-04.0	4.0	600	✓
EUFH150-04.5	4.5	675	✓
EUFH150-05.0	5.0	750	✓
EUFH150-06.0	6.0	900	✓
EUFH150-07.0	7.0	1050	✓
EUFH150-08.0	8.0	1200	✓
EUFH150-09.0	9.0	1350	✓
EUFH150-10.0	10.0	1500	✓
EUFH150-12.0	12.0	1800	✓







## Additions

For the perfect finishing touch, enhance and complement your towel rail or radiator with our collection of high quality accessories and additions. From timers to aroma oil dishes, the choice is all yours.

# Electric Element Only prices



## Standard Element

IP55 Suitable for zones 1 and 2 of the bathroom.

Each standard element contains a preset surface temperature control along with a back up fail safe, this is the only temperature control supplied, for more flexibility over the surface temperature we recommend using our AC012 (rheostat), this will give you surface temperature modulation, when fitted into the electrical supply circuit.

Available as a summer kit for dual fuel options. See page 154 for tee piece

Element Cable Length 1.5 MTR

Product	Watts
EE002	50w
EE002	75w
EE002	100w
EE002	125w
EE002	150w
EE002	200w
EE002	300w
EE002	400w
EE002	600w



## Heat Sensor Element

PX5 suitable for zones 1 and 2 of the bathroom.

Five temperature settings ranging from 30°C to 60°C.

The device displays the temperature to which it is currently set and indicates the status of the heating cycle.



Optional accessory - Heat Sensor Element Cover Shroud - AC040, to hide the cable.

Can be used when depth from wall to centre is the max of 70mm.

Element Cable Length 1.5 MTR

Product	Watts
EE006	200w
EE006	300w
EE006	400w
EE006	600w
EE006	800w
EE006	1000w



## Electronique Element

IP66 Suitable for zones 1 and 2 of the bathroom.

The standard Electronique element is set to a constant surface temperature of 52°C, with no need for external controls. In the fully loaded towel warming mode it will act to reduce power and save running costs. In space heating mode it will increase the power to deliver background heat needed to the maximum of its rated capacity. A safe to touch system, with safety measures incorporated.



Available as a summer kit for dual fuel options. See page 154 for tee piece

Element Cable Length 1 MTR

Product	Watts
EE001A	200w
EE001A	400w
EE001A	600w



## Remote Controlled Heat Element

IPX4 suitable for zones 1 and 2 of the bathroom.

Negative Temperature Coefficient technology

7 day programmable element with remote control switches the towel rail on and off when you want, at the temperature you want. Eco, boost and safety lock features included, and manual override allows you total flexibility when needed. Can be retro fitted to existing electric or dual fuel multirail towel warmers.

\*Please note, Element only suitable for vertical installation



Available as a summer kit for dual fuel options. See page 154 for tee piece

Element Cable Length 1.4 MTR

Product	Watts
EE005	300w
EE005	600w
EE005	900w



## Contract Fixed Heat / LST Electronique Element

IP55 Suitable for zones 1 and 2 of the bathroom.

Fixed Heat is designed as an energy saving element to control temperature and consume only the correct amount of power required. It maintains your pre-set temperature whether the rail is in a cold bathroom empty or fully loaded with towels. Fixed Heat for LST (low surface temperature) of 43°C must be chosen to comply with LST legislation for use in public buildings, hospitals and care homes.

Element Cable Length 1 MTR

Product	Watts
EE001C	200w
EE001C	400w
EE001C	600w

# Heating Options



Standard Rail Option (H) and (C)



Multirail Option (H) and (C)

## Heating Only Options

H

Is suitable for all heating and hot water systems. For connection to either direct (open) or indirect (closed) central heating systems.

C

Suitable for indirect (closed) central heating circuits only. It cannot be installed on an open circuit due to the product containing ferrous (steel) parts.



Standard Rail Option (E)



Multirail Option (E)

## Electric Only Options

E

A completely independent unit requiring only a fused spur electric connection. Thermal transfer fluid is heated by an electric element within the towel rail.



Standard Rail Option (D)



Multirail Option (D)

## Dual Fuel Options

D

The towel rail has the capability to run from a central heating circuit or an electric element. Handy in the summer months when the central heating is turned off.



Internal view



Rear external view

## Electric Dryline Option

DL

Electric dryline technology, with the towel warmer not containing any fluids. The towel warmer is heated using a silicone heater cable, exiting the towel warmer via a three core cable. This can then be attached to a fuse spur. Only available on specific models, please contact our sales office on +44(0)1902 387000 for further details.POA.

### Please Note:

When using the electric element only (i.e., during summer), allowance must be made for thermal expansion within the product by having the 'return' radiator valve left partially open. The 'flow' radiator valve must be closed to prevent back flow through the system. Both valves should be opened and balanced when the central heating system is operative, (i.e. during winter). Steel Rails - Must be installed in accordance with BS7593 where a corrosion inhibitor is used.

Brass Rails - Caution where water softener is installed, as this could cause dezincification (material is attacked i.e. zinc eaten away by aggressive water).

Brass towel warmers are manufactured using dezincification resistant brass, however it should be understood that the term 'resistant' does not entirely preclude the possibility of dezincification occurring. If you intend to install the product on an open (DHW) circuit, make reference to your local water authority to ensure dezincification has not previously occurred. Towel warmers manufactured from brass tubing should not be installed on an open circuit if a water softener is present. Water analysis to determine the likelihood of dezincification is available at cost.

Models suitable for indirect (closed) circuits only cannot be installed on an open circuit due to the item containing ferrous (steel) parts. Product compatibility is the responsibility of the installer.

# Fitted Electric & Dual Fuel prices

This section contains a range of elements with price supplements for electric and dual fuel models. Please add the price of your element to the model you choose and we will build it for you.



Standard Element IP55 Code EE002  
A benchmark element to suit each size of product.



Electronique Element IP66 Code EE001A  
Maintains surface temperature of product to 52 °C.



Heat Sensor Element IPX5 Code EE006\*\*  
An electronic temperature sensor control.



Remote Controlled Heat Element IPX4 Code EE005  
NTC - Negative Temperature Coefficient technology. Remote controlled programmable element for adjustable temperature control.



Fixed Heat / LST Electronique Element IP55 Code EE001C  
Ideal for LST applications where surface temperatures need to be guaranteed.

\* Dual fuel models will also be supplied with a conversion tee where applicable. This can be used with VL013 valves for a multitrail. Alternatively, to a conversion tee dual fuel valves VL015 can be used.

All the images of elements depict electric only versions. Dual fuel configurations may vary including element positioning. The appropriate standard versions will be supplied in all cases unless advised otherwise.

Electric towel warmers are filled with a glycol ethylene / water mix to strict guidelines. This improves the thermal transfer rate and acts as a corrosion inhibitor.

All electric and dual fuel towel warmers must be fitted by a qualified person.

The elements are fitted on the right hand side as standard. They can be left hand mounted on request, on certain rails only.



# IP Rating and Bathroom Zones

This section contains information on electrical safety.

IEE Wiring Regulations have identified the following zones and IP ratings to ensure safety.



## IP Zoning

<b>ZONE 0</b>	Inside the bath or shower. Any fitting here must be SELV (max 12v) and a minimum rating of IPX7. (Protection against immersion in water).
<b>ZONE 1</b>	Above the bath or shower to a height of 2.25m. A minimum rating of IPX4 is required * See note 1.
<b>ZONE 2</b>	The area stretching to 0.6m outside the bath or shower and above the bath or shower if over 2.25m. A minimum rating of IPX4 is required * See note 1.
<b>OUTSIDE ZONES</b>	Anywhere outside zones 0, 1, and 2. Where water jets are not used for cleaning purposes, the general rules BS7671 apply. * See note 1.

All final circuits require 30mA RCD protection.

- In zones 1 and 2 if there is a likelihood of water jets being used for cleaning purposes a minimum of IPX5 is required.
- Where ceiling heights exceed 2.25m, the zones are effectively up to 3m, beyond 3m the walls are out of scope.
- Basins are not covered, however they are usually considered zone 2.
- If the space underneath a bath cannot be accessed without tools that space is considered out of zone.
- Information contained on this page is for guidance only. Please refer to current IEE Regulations or a qualified electrician.

## IP Rating Guide

An IP rating is, in summary, a two digit code. The first digit establishes the level of protection against intrusion of foreign bodies. The second the resistance against moisture intrusion. Together, this informs you of precise the level of protection that will be offered by the specific case or enclosure. for more information please see BS EN 60529:1992+A2:2013, European IEC 60509:1989.

### First Digit

Protection against solid foreign objects and access to hazardous parts.

At the lowest of seven levels is 0, this means no protection is offered. At the highest level 6, there shall be no entry of dust particles.

### Second Digit

Protection against entrance of water on a progressive scale. At level 1 dripping water shall have no effect. at level 6 water from powerful jets against the enclosure shall have no effect.

The letter X can be used in place of the first digit or second digit to indicate that tests have not being carried out or are not applicable.

0		No protection.	0		No protection.
1		Protected against solid objects larger than 50mm e.g. accidental touch by hands.	1		Protected against vertically falling drops of water e.g. condensation.
2		Protected against solid objects larger than 12.5mm e.g. fingers.	2		Protected against direct sprays of water up to 15° from the vertical.
3		Protected against solid objects larger than 2.5mm e.g. tools and cables.	3		Protected against direct sprays of water up to 60° from the vertical.
4		Protected against solid objects larger than 1mm.	4		Protected against water splashed from all directions - limited ingress permitted.
5		Protected against dust (no harmful deposits).	5		Protected against low pressure jets of water from all directions - limited ingress permitted.
6		Totally protected against dust.	6		Protected against strong jets of water e.g. for use on ship decks - limited ingress permitted.
			7		Protected against the effects of temporary immersion in water between 150mm and 1m.
			8		Protected against continuous submersion at a specified depth.

IEC 529, BS EN 60529 DOES NOT APPLY TO ANY RISK OF EXPLOSION OR CONDITIONS SUCH AS HUMIDITY, CORROSIVE GASES, FUNGI OR VERMIN. IN CERTAIN CASES EQUIPMENT DESIGNED TO BE MOUNTED IN AN ENCLOSURE WILL CONTRIBUTE TOWARDS THE STATED IP RATING (EG PUSH BUTTONS MOUNTED IN AN ENCLOSURE). DIFFERENT PARTS OF ENCLOSURES CAN HAVE DIFFERENT DEGREES OF PROTECTION AND STILL CONFORM TO THE STANDARD (E.G. ENCLOSURES WITH PRE-DRILLED CONDUIT ENTRY). ALL INFORMATION STRICTLY FOR GUIDANCE ONLY, PLEASE REFER TO REGULATIONS AND MANUFACTURERS FOR INFORMATION IF YOU ARE IN ANY DOUBT.

# Accessories



AC002  
Ball vent.



AC003  
Conversion tee for dual energy radiators.



AC004  
Valve sleeves.



AC005  
Connection tubes.



AC006  
Street elbow connection tubes.



AC031  
Clip on frosted sphere and chrome robe hook.

## AC007

Electric element shroud covers. Shown as standard in chrome. Other finishes are available, please contact the sales office for a quote.



\*Please be aware that some cover shrouds conceal the element block and cable but NOT the service nut. If unsure, please ask your Dealer for more information prior to ordering.



AC035  
Blanking Plug with Aroma Oil Dish.



AC040  
Heat Sensor Element Cover Shroud  
Can be used when depth from wall to centre is the maximum of 70mm.



AC060  
Air vent cap.



AC065  
Universal chrome robe hook.

Product	Description	Stock or made to order
AC002	1/2" BSP M.I. Decorative air vent and plug	✓
AC003	Three point 1/2" BSP adaptor. For electric element and radiator valve link	✓
AC004	19 mm ø x 100 mm long, electroplated to match towel rail and valves	✓
AC005	15 mm ø x 150 mm long	✓
AC005	22 mm ø x 150 mm long	✓
AC006	15 mm ø x 150 mm long	✓
AC007A	Legacy ball joint	✓
AC007B	Contemporary	✓
AC007C	Mitred	✓
AC007D	Flexi (suitable for use with standard element only)	✓
AC007E	Preset (suitable for use with EE001c, EE005 & EE006)	✓
AC007F	Originals ball joint	✓
AC007G	Electronique (suitable for use with electronique element only)	✓
AC007H	Hexagonal	✓
AC035	Oil Aroma Blanking Plug	✓
AC040	Heat Sensor Element Cover Shroud	✓
AC031	Chrome and frosted sphere. Suitable for MD001, MD003, MD005 and MD034	✓
AC060	Air vent cap (per pair) to fit over radiator vent & blanking plug	✓
AC065	Universal Chrome robe hook. Suitable for MD062, MD063, MD001, MD002, MD006, MD003, MD004, MD034	✓

# Accessories

**AC012 Voltage Regulator**  
A manual controller to manage power consumption to your towel warmer.



**AC013 7 Day Timer**  
This digital controller gives you the facility to pre plan when you will need your towel rail on and off.



**AC014 Pattress Plate**  
Housing the wires from the towel rail element if no external controller is required.



**AC023**  
Clip on chrome towel bar in two widths.



**AC030**  
Magnetic towel bar.



**AC010**  
Round or square metal cover plates.

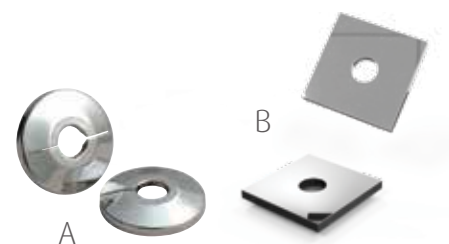

**AC032**  
Stainless steel towel bar.



**AC034**  
Towel Bar for CN027



**AC011**  
Arne straight or angled fixing kit.



**AC011F**  
Crosshead angled fixing kit.



**AC011S**  
Piazza angled fixing kit.



2

**AC011A & AC011B ARE AVAILABLE IN OUR CONTEMPORARY COLOUR FINISHES POA.**

Product	Description	Stock or made to order
AC010A	Round 15 mm internal diameter hinged cover plates	✓
AC010B	Square 15 mm internal diameter cover plates	✓
AC011A & AC011B	VL003 (pair) straight or angled valves with cover plates and connection tubes	✓
AC011F	VL008 (pair) angled valves with cover plates and connection tubes	✓
AC011S	VL0014 (pair) angled valves with cover plates and connection tubes	✓
AC012	Chrome 75W - 400W (1 gang)	✓
AC012	Chrome 150W - 1000W (2 gang)	✓
AC013	Digital single channel programme timer (White or Chrome)	✓
AC014	Covers 1 gang pattress box (Chrome)	✓
AC023B	Chrome 305 mm wide, suitable for MD001, MD005 and MD034	✓
AC023C	Chrome 395 mm wide, suitable for MD001, MD005 and MD034	✓
AC030	Chrome 443 mm wide, suitable for MD056	✓
AC032	Stainless steel 450 mm wide, suitable for DR003 and DR021	✓
AC034A	Towel Bar for CN027 - 60mm wide x 200mm wide Chrome, White or Anthracite	✓
AC034B	Towel Bar for CN027 - 60mm wide x 340mm wide Chrome, White or Anthracite	✓
AC034C	Towel Bar for CN027 - 60mm wide x 480mm wide Chrome, White or Anthracite	✓

# Valves



**Arne VL003**

A modern valve that works with many designs. Available in our contemporary colour finishes.



**Arne Thermostatic VL004**  
Controlling the heat of your towel rail or radiator.



**Xero VL012**

This modern tap head style suits many bathroom taps and fittings.



**Piazza VL014**

This cubed valve gives a great finish to our square tube products.



**Combination Kit VL013**

A combination kit of VL003 straight and angles valves for a dual energy option, applicable for all multirail products.



**Adapta VL001**

A contemporary double angled valve, almost not to be noticed.

## Dual Fuel Valves VL015

For both central heating and electric dual fuel options.



## The Contemporary Colour Arne VL003 valves



Mocha Textured



Anthracite Textured



Matt White Textured



Satin Black



Latte Textured



Grey Sparkle Textured



Matt Black



Cappuccino Textured



Espresso Gloss

2

\*Arne VL003 valves are available in Chrome and White (9016) as standard or one of our Contemporary Colours as an option for the same price.

Valve	Description	Type	Stock or made to order
Arne VL003	1/2" BSP X 15 mm	Straight	✓
Arne VL003	1/2" BSP X 15 mm	Angled	✓
Arne Thermostatic VL004	1/2" BSP X 15 mm thermostatic	Straight	✓
Arne Thermostatic VL004	1/2" BSP X 15 mm thermostatic	Angled	✓
Adapta VL001	1/2" BSP X 15 mm	Angled	✓
Xero VL012	1/2" BSP X 15 mm	Angled	✓
Piazza VL014	1/2" BSP X 15 mm	Angled	✓
Combination Kit VL013	1/2" BSP X 15 mm	Angled / Straight	✓
Dual Fuel VL015	1/2" BSP X 15 mm	Angled	✓



Art Deco VL006

These valves work well with the hexagonal tube deco designs.



Crosshead VL008

A valve that suits most traditional designs. Our benchmark.



Crosshead 2 VL018

A capstan style valve, which suits ball jointed products.



Excelsior VL010

Thermostatic, a substantial valve in a time honoured design.



Arne Corner VL023

A discreet contemporary valve that neatly aligns with your towel warmer.



Arne Corner Thermostatic VL024

Thermostatic version of our discreet corner valves.

2

Valve	Description	Type	Stock or made to order
Art Deco VL006	1/2" BSP X 15 mm	Angled	✓
Crosshead VL008	1/2" BSP X 15 mm	Straight	✓
Crosshead VL008	1/2" BSP X 15 mm	Angled	✓
Excelsior VL010	1/2" BSP X 15 mm thermostatic	Angled	✓
Crosshead 2 VL018	1/2" BSP X 15 mm	Angled	✓
Arne Corner VL023	1/2" BSP X 15 mm	Corner	✓
Arne Corner Thermostatic VL024	1/2" BSP X 15 mm thermostatic	Corner	✓

Straight Valves



Angled Valves



All valves are supplied as standard in a chrome finish. Other finishes are available.

Please Note: Designs may differ slightly when ordering in different finishes. Please contact our sales office on 01902 387000 to discuss your requirements.

# Vogue UK Painted Colours and Finishes

The colours and finishes below are available on many of our ranges carrying the RAL colour symbol.



Silver crackle



Copper crackle



Bronze crackle



Modern Copper



Modern Steel



Modern Silver



Modern Bronze



Modern Gold



Modern Polished Brass POA



Modern Brushed Brass POA



RAL 1013



RAL 9001



RAL 1015



RAL 9010



RAL 9003



RAL 7035



RAL 7016



RAL 6005



RAL 5012



RAL 5015



RAL 5017



RAL 3020



RAL 3000



RAL 3002



RAL 9005



## Vogue UK Radiator Colours - POA



RAL 1018



RAL 1028



RAL 2011



RAL 8023



RAL 8011



RAL 8017



RAL 7011



RAL 6018



RAL 6019



RAL 6027



RAL 5009



RAL 7040



RAL 4003



RAL 4005

The RAL colours in this chart have been matched as closely as possible. The colour depends on the printing. We suggest an official RAL colour chart gives the most accurate representation.

## Vogue UK Contemporary Colour Range



Matt White Textured



Grey Sparkle Textured



Matt Black



Satin Black



Espresso Gloss



Anthracite Textured



Latte Textured



Cappuccino Textured



Mocha Textured

The contemporary colour range is available as a stocked item in three models Serene, Vela and Focus. White & Grey Sparkle Textured, Latte, Cappuccino, Mocha and Anthracite have a textured finish, with Espresso and Satin Black being gloss. These finishes are also available on other ranges.

# Vogue UK Metallic Finishes

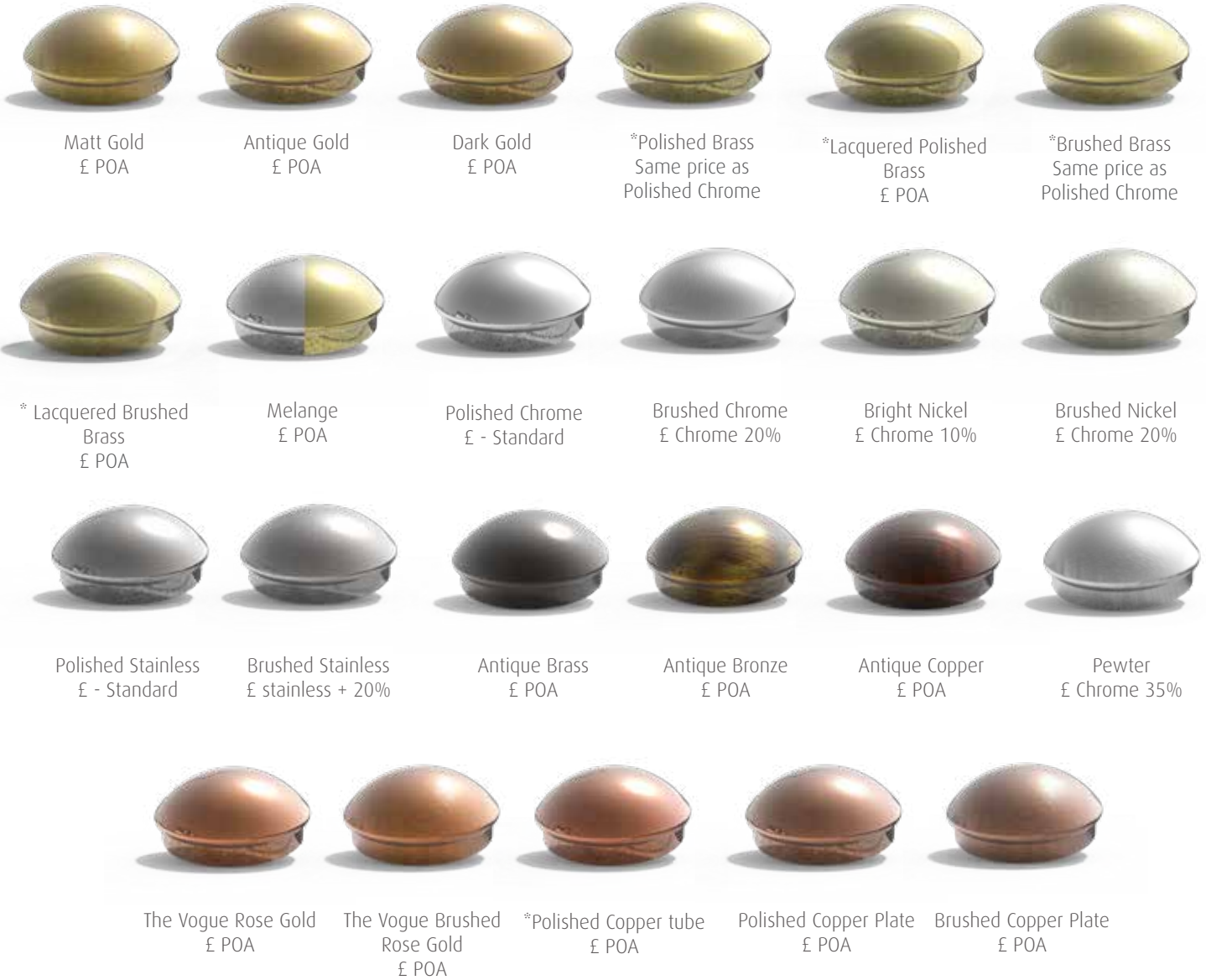

Please note : Polished Brass and Polished Copper tube finishes, are supplied in a raw, un-lacquered finish, as standard. This un-lacquered (ie; unprotected) base material will discolour in a short period of time and will therefore require regular cleaning in order to maintain the finish. To add a lacquer to preserve the finish, add an additional 20% to the un-lacquered price. Brushed Brass will be supplied as a lacquered finish only and subject to an additional 20% supplement charge on top of the chrome finish price.

Antique Bronze, Antique Brass & Antique Copper - Due to the reaction between the solution with the base metal there will always be a degree of natural variation in shading between different components.

## Inset Radiator Range



Column



Convactor



Flat Panel

# Joints & Tubing

Selecting your joint and tube design could not be more flexible.

Our hand made selection of towel warmers can be as individual as you are.

## Vogue UK Tubing Range

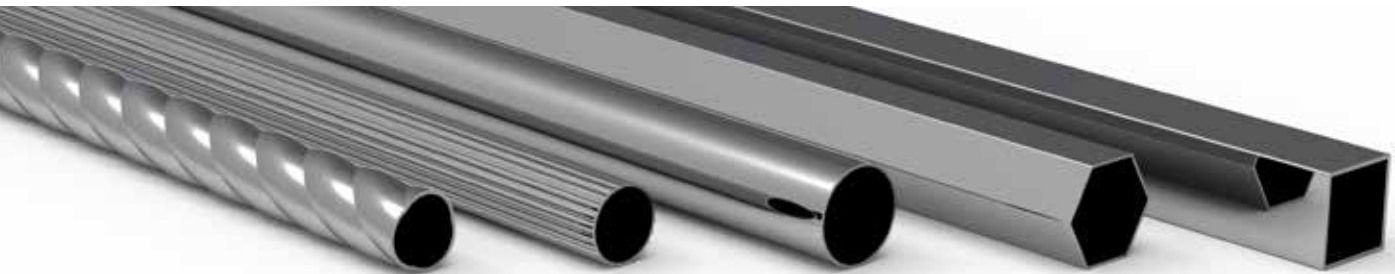

Rope

Reed

Plain

Hexagonal

Square

## Vogue UK Joint Range



Ball Joint 1"



Legacy Ball Joint 1.25"



Originals Ball Joint



Charlotte Ball Joint 1.5"



Grandeur Joint



The 1909 Ball Joint

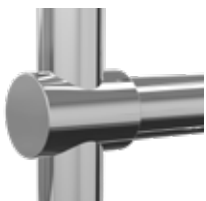

Cylinder Joint



Art Moderne Corner



Minama Square Corner



Romolo Joint



Art Linea Joint



Mitred Corner



Plain Corner



Contemporary Corner



Minama Round Corner



Valour Bend



## General Information

Bespoke items are non-returnable. Please note that certain non-stock models are also non-returnable, please confirm with our Sales Office on telephone +44(0)1902 387000.

All heat outputs are shown at  $\Delta T$  50°C, in compliance with BSEN442 - Specification for Radiators and Convectors. To convert to  $\Delta T$  60°C, multiply heat output by conversion factor 1.264 (approximate figure), to convert to  $\Delta T$  70°C, multiply heat output by conversion factor 1.549 (approximate figure).

All measurements given are nominal dimensions only (mm), and are not binding. Detailed technical drawings are available on request from our Sales Office on +44(0)1902 387000 or via our website - [www.vogueuk.co.uk](http://www.vogueuk.co.uk)

Manufactured from hot brass stamped fittings and high quality brass tube complying to BS EN 12449:2016+A1:2019. Some models are manufactured from high grade CR steel tubing and/or containing steel components suitable for closed/indirect circuits only. All rails are pressure tested to at least 5.4 bar (78psi) up to a maximum of 13 bar (189psi) air immersed in water. All models are fitted with two ½" BSP F.I. connections. Alternative M.I. or compression fitting is available on request. ¾" BSP F.I. connections available at extra cost on some models. A manual bleed air vent is fitted to all hot water/dual fuel models. Auto air vents available on request at additional cost.

In compliance with our policy of constant improvement we reserve the right to alter specifications, materials and dimensions or discontinue any of our products without prior notice. The colours in the brochure are as accurate as the colour printing processes allow. Photographs and images are for illustrative purposes only. We reserve the right to change specifications without prior notification.

Products ordered incorrectly or where the specification has changed will incur a re-stock charge. Bespoke/custom made products are non-refundable. Upon the return of a product Vogue (UK) Ltd reserve the right to refuse credit if the product is not made available upon an agreed collection/return in line with the Company's terms and conditions.

A copy of the Company's full Terms and Conditions of Trading is available on request.

## Installation

Vogue (UK) Ltd recommends that existing or new pipework is not adjusted until the towel warmer or radiator has been delivered and is in its final position.

Pipe centres are provided as centre to centre tapings using the Vogue (UK) range of valves. Valves are NOT supplied with each product. Please see Valves & Accessories section for further details. All installations of a Vogue (UK) Ltd towel warmer or radiator should be in accordance with the following British Standards;

-BS 7593:2019 Code of Practice for the preparation, commissioning, and maintenance of domestic central heating and cooling water systems (In short, clean, protect, test & maintain).

-BS EN 14336:2004 Heating systems in buildings – Installation and commissioning of water-based heating systems

-BS EN 12828:2012 Heating systems in buildings – Design for water-based heating systems.

## EN442.1 & 2

Where applicable product within this publication has undergone independent testing to verify heat outputs are in accordance with



the parameters laid down in the above European standards.

## EN60335

Household and similar electrical appliances. Safety.

Part 2 - 43 : 2003 + A2 : 2008

Where applicable all product within this publication utilising an electrical heating component, conform to the above safety standard.

## ISO 9001:2015 Certified

Vogue (UK) Ltd is proud to be ISO 9001: 2015 certified.

Quality is utmost in importance to our organization, in both the products and services we provide our customers. Reflecting this commitment, Vogue (UK) Ltd implemented and received certification of our Quality Management System in accordance with ISO 9001:2015.

## Construction Product Regulations (CPR)

In compliance with the above, Vogue (UK) Ltd (The company) holds declaration of Performance Certificates (DoPs) for all products covered by the Harmonised Standard EN442.1 / 2. Copies of relevant certificates are available on request. Some products at the time of print may be awaiting confirmation.

Product with a declared heat output of 200Watt or less 50 degree C Delta T are not classified by The company as heating appliances and are therefore not covered by the above. All individually manufactured bespoke products are similarly exempted from the above legislation.

## Warranty

Vogue (UK) Ltd is a company that celebrates the wealth of traditional, quality handcrafted heated towel warmers and radiators and is one of the last true manufacturers in the UK. Vogue branded towel warmers installed within the UK are also covered by an extended 2, 15 or 30 Year product warranty – subject to our business trading Terms & Conditions against manufacturing defects. Components such as inset radiators, not of our manufacture, which become faulty by reason of defected materials, come with a 2 year warranty only.

## Continual Improvement

Our company policy is one of continual improvement and Vogue (UK) Ltd reserves the right to amend designs, specification or discontinue any of our products without prior notice. E & OE

## Carriage

Paid UK mainland, excluding requests for next day service, Export carriage can also be arranged. Please contact our Sales Office for details on telephone +44(0)1902 387000.



# Index

Model	Code	Material	Section	Style	Installaton	Page
<b>A</b>						
Accessories	AC		A	AC		154
Amie	CN065	MS	CN	MTW	WM	23
Aquila	DR016	MS	CN	DTW	WM	40
Arc	MD065	MS	CN	MTW	WM	37
Arcadia	LG017/OG017	MS/BR	TR	TTW	FM	92
Art Moderne	OG011	BR	TR	TTW	FW	104
Art Moderne	OG010	BR	TR	TTW	WM	105
Art Moderne II	OG021	BR	TR	MR	WM	106
Astute Compact	DR034	AL	DR	DR	WM	131
Astute Horizontal	DR036/DR036DP	AL	DR	DR	WM	130
Astute Towel Warmer	CN095	AL	CN	MTW	WM	65
Astute Vertical Double	DR035DP	AL	DR	DR	WM	133
Astute Vertical Single	DR035	AL	DR	DR	WM	132
Axis Chrome	MD062	MS	LR	MR	WM	68
Axis Matt Black	MD062	MS	LR	MR	WM	69
<b>B</b>						
Ballerina	LG024A-MS/LG021-MS	MS	TR	TTW	FW	94
Ballerina	LG024/LG021/OG003	BR	TR	TTW	FW	95
Ballerina	LG010A-MS	MS	TR	TTW	WM	96
Ballerina	LG025/LG010/LG021/OG002	BR	TR	TTW	WM	97
Baroque	LG014/OG016	MS/BR	TR	TTW	FM	93
Basin Stands		BR	TR	TTW	FW/WM	114
Bathroom Zones			A			153
Binary	TR002	BR/MS	CN	S	WM	57
Boxa	CN009	MS/SS	CN	MTW	WM	36
Butler	LG035/OG004	BR	TR	TTW	FW	100
<b>C</b>						
Carina	MD051	MS	CN	S	WM	60
Chic	MD046	MS	CN	DTW	WM	24
Chorus	MD002	MS	LR	MR	WM	73
Chube	MD035	SS	LR	MR	WM	76
Colonnade IV	LG023	BR	TR	TTW	WM	108
Colour options			A			158
Combes	MD063	MS	LR	MR	WM	70
Comby	MD052	MS	CN	MR/S	WM	58
Comfort	EL028	MS	E	ETW	WM	142
Concertina	DR010	MS	CN	DR/DTW	WM	12
Contrast	MD079	MS	CN	MTW	WM	29
Curvee	MD050	MS	CN	MR	WM	42
Cygnus	DR012	MS	CN	DR/DTW	WM	14
Cygnus Harmonique	DR032	MS	CN	RTW	WM	15
<b>D</b>						
Decor	MD084	MS	CN	MTW	WM	44
Décor Harmonique	MD094	MS	CN	RTW	WM	45
Draco	DR015	MS	CN	MTW	WM	16
<b>E</b>						
Electric Element & Dual Fuel Fitted Pricing			A			152
Electric Elements	EE001/EE002/EE003/EE005/EE006		A	EL		150
Electric Under Floor Heating	EUFH		E	UFH		146
Elizabeth	LG003/OG019	MS/BR	TR	TTW	FW	102
Elizabeth	LG003/OG019	BR	TR	TTW	WM	103
Envirovent Electric Fans	SILD/ECO DMEV/SILM/SIL	N/A	E			144

Model	Code	Material	Section	Style	Installaton	Page
<b>F</b>						
Flexx	CN015	BR	CN	MTW	WM	18
Fly Line Horizontal	DR004/DR004DP	MS	DR	FR	WM	127
Fly Line Vertical	DR003/DR003DP	MS	DR	FR	WM	126
Focus	MD001	MS	LR	MR	WM	72
Focus Colour Range	MD001	MS	LR	MR	WM	75
Focus Horizontal	MD001	MS	LR	MR	WM	74
<b>G</b>						
Galaxy	MD059	SS	LR	MR	WM	78
Gallant	MD040	SS	CN	MR	WM	38
Gallant II	MD040	MS	CN	MR	WM	39
Grace	MD067	MS	CN	MTW	WM	20
Grandeur	GD032FW	BR	TR	TTW	FW	98
Grandeur	GD032WM	BR	TR	TTW	WM	99
<b>H</b>						
Hamlet	LG037/OG001	BR	TR	TTW	WM	101
Harmonique	MD060	MS	CN	RTW	WM	61
Harmonique Duo	MD090	MS	CN	RTW/S	WM	59
Heating Options			A			151
<b>I</b>						
Ideal	MD055	SS	CN	MTW	WM	35
Ieri	TM014-MS	MS	CN	S	WM	54
Ieri	TM014-BR	BR	CN	S	WM	55
Intra	CN013	BR/MS	CN	MTW	WM	19
<b>J</b>						
Joints & Tubing			A			160
<b>K</b>						
Kate	DR019	MS	DR	DR/VT	WM	122
Kerve	MD036	SS	LR	MR	WM	77
Keys II	CN030	MS	CN	DTW	WM	25
<b>L</b>						
Lure Double	DR020DP	MS	DR	DR/VT	WM	129
Lure Single	DR020	MS	DR	DR/VT	WM	128
<b>M</b>						
Mantra V	CN075	MS	CN	MTW	WM	21
Marine	DR009	MS	CN	DR/DTW	WM	13
Melody	MD004	MS	LR	MR	WM	81
Metallic Finishes			A			159
Mode Accessories	AC					138
Mode Bespoke	2C/3C/4C/5C/6C	MS	DR	CR	WM	138
Mode Column Radiator	2C/3C/4C	MS	DR	CR	WM	136
Mode II	CN027	MS	DR	CR	WM	134
<b>N</b>						
Nexus Grand III	TM003	BR	TR	RTW	WM	110
Nexus Grand IV	TM004	BR	TR	RTW	WM	111
Nexus III	TM001	BR	CN	RTW	WM	62
Nexus IV	TM002	BR	CN	RTW	WM	63
<b>O</b>						
Ordinate	MD005	MS	DR	VT	WM	123
<b>P</b>						
Pearl	MD058	SS	LR	MR	WM	79
Penthouse	LG018/OG020	BR	TR	MR	WM	107
Phoenix	DR017	MS	CN	DTW	WM	41

# Index

Model	Code	Material	Section	Style	Installation	Page
Pure	MD037	BR	CN	MTW	WM	22
Q						
Quadrate	MD074	MS	CN	MTW	WM	30
Quadrate Harmonique	MD078	MS	CN	RTW	WM	31
R						
Regency	LG004-MS	MS	TR	TTW	FW	86
Regency	LG004-BR/OG006-BR	BR	TR	TTW	FW	87
Regency	LG005/OG015	MS/BR	TR	TTW	WM	88
Regency II	LG036/OG009	BR	TR	TTW	WM	89
Regency Tall	LG013-MS	MS	TR	TTW	FW/WM	90
Regency Tall	LG013-BR/OG007-BR	MS	TR	TTW	FW/WM	91
Rubik	MD038	SS	CN	MTW	WM	32
S						
Sequel III	TM005	BR	TR	RTW	WM	112
Sequel V	TM006	BR	TR	RTW	WM	113
Serenade	DR008	MS	DR	FR	WM	125
Serene	MD049	MS	CN	MR	WM	34
Shower Curtain Rails	SCR1 - 6	BR	TR		WM	116
Sierra	DR040	MS	CN	MTW	WM	17
Simplicity II	EL040/EL045	SS	E	VT	WM	143
Simplicity IV	IVCN026	BR	CN	TTW	WM	51
Smooth	CN035	MS	CN	MTW	WM	26
Smooth II	CN036	MS	CN	MTW	WM	27
Solo	TR001	BR/MS	CN	S	WM	56
Squire	MD047	MS	CN	MR	WM	33
Stella	MD034	SS	LR	MR	WM	82
Studio	MD006	BR	LR	MR	WM	83
Suave	MD056	MS	DR	FR	WM	120
T						
Tempo	MD072	MS	CN	MR	WM	64
Tune	MD003	MS	LR	MR	WM	80
U						
Unique	CN028	MS	CN	MTW	WM	46
V						
Valves	VL		A	VL		156
Vela	MD048	MS	CN	MR	WM	43
Venture	CN022	BR	CN	TTW	WM	47
Vintage	LG010B	BR	TR	TTW	WM	109
Vision	DR022	MS	DR	DR/VT	WM	124
Vivid	CN021	BR	CN	TTW	WM	48
Vivid II	CN029	BR	CN	TTW	WM	49
Vivid IV	IVCN021	BR	CN	TTW	WM	50
Vivid IV Horizontal	IVCN021	BR	CN	TTW	WM	52
Vivid IV Horizontal	IVCN021	BR	CN	TTW	WM	53
Z						
Zenith	IN007	SS	CN	MTW	WM	28
Zest	MD076	MS	DR	FR	WM	121

## Innovation

Vogue UK is a vibrant organisation with research being conducted in many technology disciplines. This research results in exciting products as evidenced throughout the design collections we offer. Vogue UK has set itself a clear objective: both through consistent preservation and long tradition of British craftsmanship and meeting its high standards, as well as creating, with its very own innovative heating developments, contemporary design and a heightened passion for detail and perfection.

Those who appreciate lasting value derived from the synergy of traditional craftsmanship, creative development and the latest technology, as well as dedication in seeking the extraordinary know not to entrust any towel rail design but rather to a design crafted from Vogue (UK).

Vogue UK emphasises its creative drive to differentiate its towel rail designs down to the finest detail and its desire to monitor, to the greatest possible extent, the development and manufacture of a hand crafted product. We use the latest technology to produce low-volume individual parts with high added value continuously offering home interiors and connoisseurs of design new, impressive towel rail models.

## Environment

Vogue UK has a legacy of core values, rooted strongly in safety, health and environmental stewardship. For 30 years, we have been reducing the environmental footprint of our own operations. Today, footprint reduction is expected of all companies. The challenge – and the opportunity – are products and manufacturing processes that are safer, less toxic, more energy efficient, use less water, less energy, and produce fewer greenhouse gases.

We're working to conserve energy and reduce waste and are exploring the use of sustainable materials and products. Whether we're saving costs by reducing energy consumption or creating covetable products through innovative, sustainable design, we believe that reducing our impact on the environment can also result in positive business benefits.

## INDEX KEY

Style		Material		Section		Installation	
C	Column radiator	BR	Brass	CN	Contemporary	FM	Floor Mounted
DR	Designer radiator	MS	Mild Steel	LR	Ladder Rails	WM	Wall Mounted
DTW	Designer towel warmer	SS	Stainless Steel	TR	Traditional	FW	Floor and Wall Mounted
ER	Electric radiator	AL	Aluminium	DR	Designer Radiators		
FR	Flat Radiator	CI	Cast Iron	E	Electric		
MR	Multirail			A	Additions		
MTW	Modern towel warmer						
RTW	Radiator towel warmer						
S	Shelf						
TTW	Traditional towel warmer						
UFH	Under floor heating						
VT	Vertical tube						

Vogue (UK) Ltd  
Strawberry Lane  
Willenhall, West Midlands  
WV13 3RS United Kingdom

T: +44(0) 1902 387000 F: +44(0) 1902 387001  
E: sales@vogueuk.co.uk W: www.vogueuk.co.uk



**VOGUE UK**  
TOWEL WARMERS & RADIATORS

Vogue (UK) Ltd  
Strawberry Lane  
Willenhall, West Midlands  
WV13 3RS United Kingdom

T: +44(0) 1902 387000 F: +44(0) 1902 387001  
E: [sales@vogueuk.co.uk](mailto:sales@vogueuk.co.uk) W: [www.vogueuk.co.uk](http://www.vogueuk.co.uk)